

RM6 up to 24 kV

Gas Insulated Ring Main Unit



Gas Insulated Switchgear (GIS)
Ring Main Unit up to 24 kV

Contents

Contents

Presentation **A-1**

The RM6 range **B-1**

Unit characteristics **C-1**

Network remote control **D-1**

Accessories **E-1**

MV connection **F-1**

Installation **G-1**

Order form **H-1**

Your needs

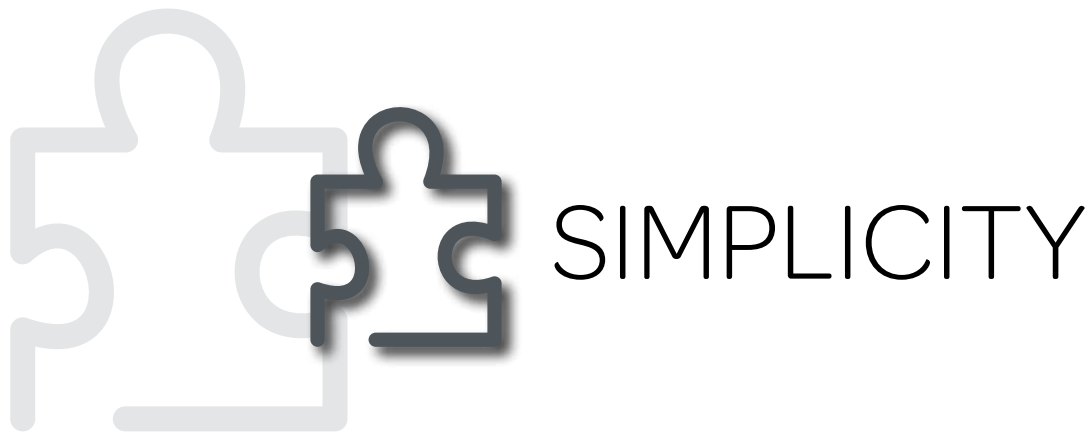

RM6 solution

The RM6 is a compact unit combining all MV functional units to enable connection, supply and protection of transformers on an open ring or radial network: it is a complete range to meet the needs of sectors of the energy, of the industry and the building.

- **An incomparable field-proven experience:** with over 1 300 000 functions installed worldwide.
- **High Quality:** thanks to the stringent application of the standards of ISO quality 9001 and ISO 9002 during the Conception, Manufacture, and rigorous Tests and Control of the product.
- **An assurance of maintain of continuity of service:** the conception of the RM6 confers it a real complete insulation which ensures to the switchgear a total resistance against severe environments, whether it is the dust, or humidity.
- **A simple and limited maintenance:** with a periodicity from 5 to 10 years
- **Easy to install:** due to its compact dimensions and quick settle. If your installation evolves, RM6 adapts itself to respond to your growing needs: on-site extensibility without manipulation of gas nor particular preparation of the ground allow you to develop your installation simply and safely.
- **Operate safely:** The safety of the person is for us a major commitment. RM6 guarantees a total safety thanks to the internal arc proof.
 - Contact of earthing is clearly visible.
 - The voltage indicators are located on the front face.
 - Ultra-reliable device and a natural interlocking ensured by a simple to understand overview diagram on the front side.
- **Safety for operator:** the real position of the contact on earth position before working on the cubicle. The moving contacts of the earthing switch are visible in the closed position through transparent windows.
- **Transformer protection with a circuit breaker:** offering adjustable tripping curve, overload protection, earth fault protection always ready, and avoiding fuse replacement, and stock. In addition it allows immediate reclosing possibility even remotely.



1700000

1700 000

RM6 protects persons and installations all around the world with 1700 000 functions installed in applications of Medium Voltage secondary distribution networks.

Contents

| | |
|------------------------------|-----|
| Applications | A-2 |
| Range advantages | A-5 |
| Experience of a world leader | A-6 |
| Protecting the environment | A-7 |
| Quality - Standards | A-8 |



Applications

The RM6 can be adapted to meet all Medium Voltage power distribution needs, up to 24 kV.

The RM6 is a compact unit combining all MV functional units to enable connection, supply and protection of transformers on an open ring or radial network:

- by a fuse-switch combination, up to 2000 kVA ;
- by a circuit breaker with protection unit, up to 8000 kVA.

The switchgear and busbars are enclosed in a gas-tight chamber, filled with SF6 and sealed for life.

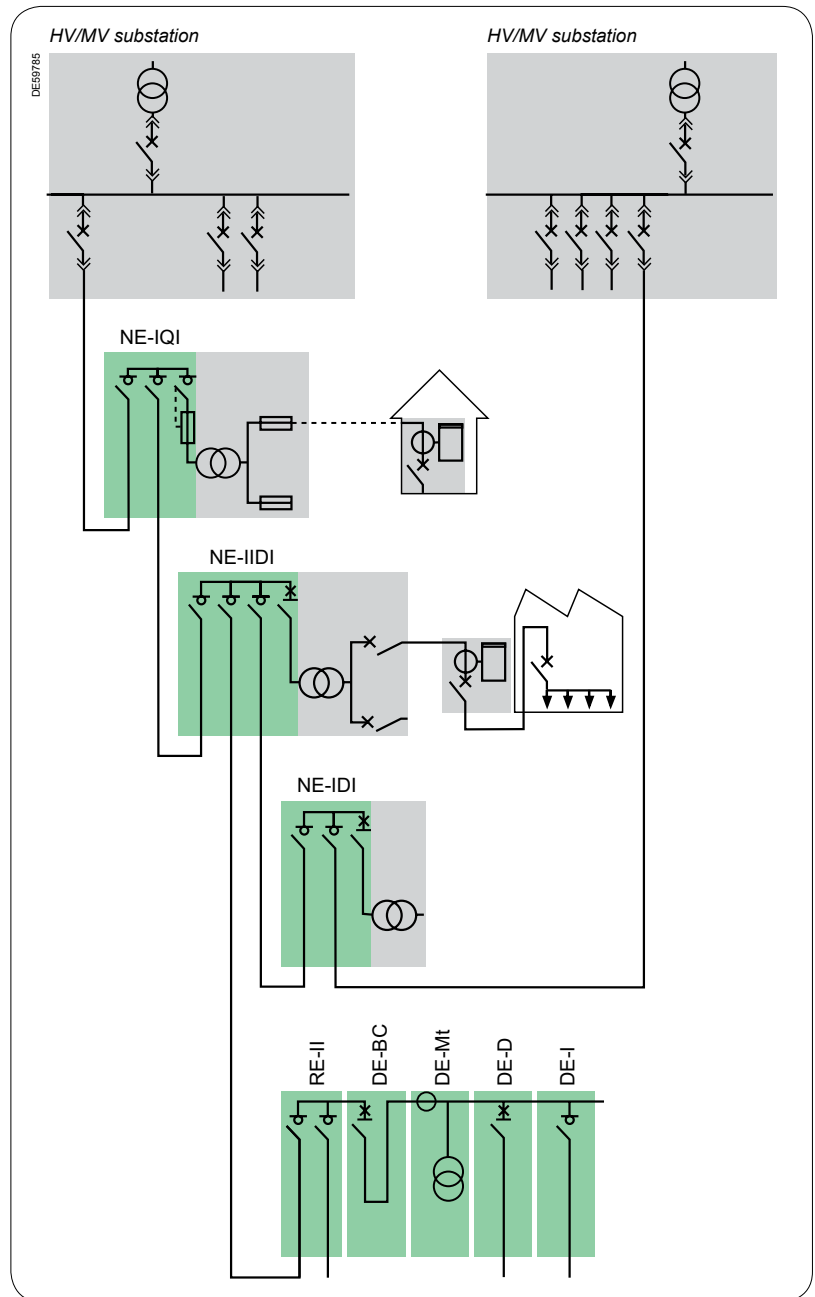
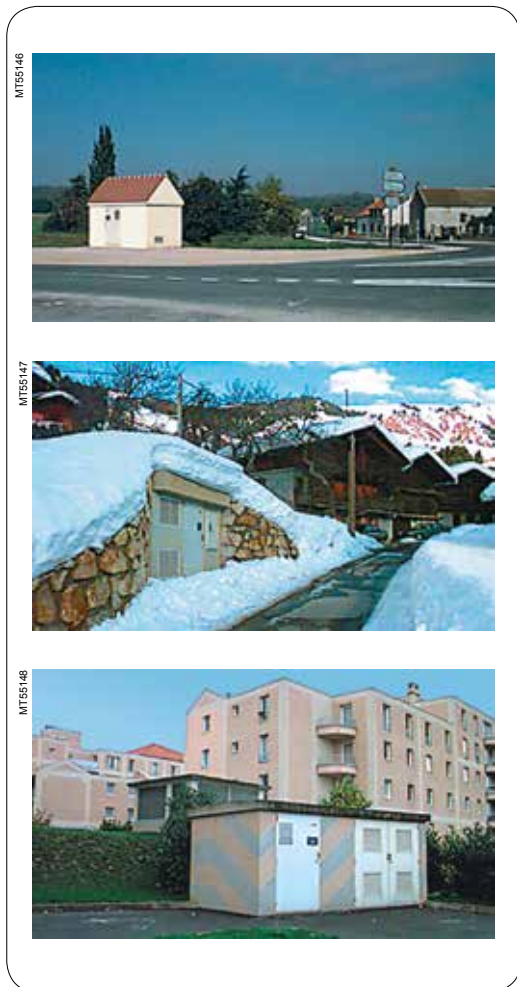

Applications

A complete range, enabling you to equip MV network points, and enhance electrical power dependability.

Operating a distribution network sometimes requires switching points in addition to the HV/MV substations, in order to limit the effect of a fault on the network.

The RM6 offers a choice of solutions to make 2, 3, 4 or 5 directional connections

- with line protection by 630 A circuit breakers
- with network switching by switch-disconnectors
- with integrated power supply telecontrol devices.

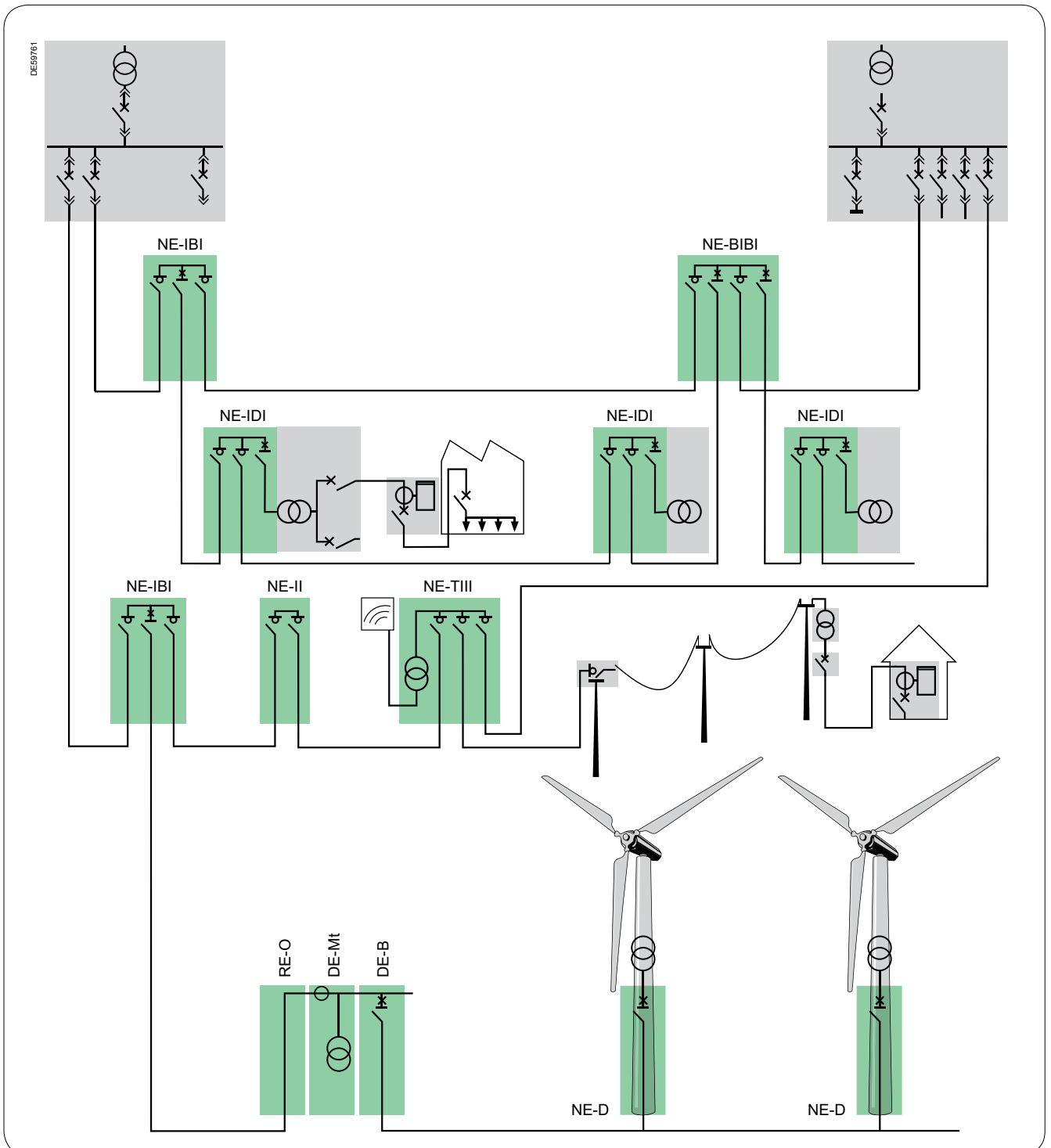

Applications

Choosing RM6 offers you the experience of a world leader in the field of Ring Main Units

The choice for your peace mind

The new RM6 generation benefits from the accumulated experience acquired from the 1,000,000 functional units that equip electrical networks in more than 50 countries in Africa, America, Asia, Europe and Australasia.

With 20 local production units around the world, Schneider Electric offer products can be made available to you in the shortest possible time.

Ring Main Unit, long experience

- **1983:** marketing launch of the first RM6 compact with integrated insulation.



- **1987:** creation of the circuit breaker version, with integrated protection unit needing no auxiliary power supply.



- **1990:** creation of the RM6 1 functional unit.
- **1994:** creation of the Network Point, integrating the RM6 and telecontrol.
- **1998:** creation of the 630 A line protection integrated relay circuit breaker and launch of an RM6 range that is extensible on site.
- **2007:** creation of the MV metering offer and associated functions (metering module, busbar coupling module, cable connection module).
- **2011:** creation of RM6 Free Combination.
- **2012:** creation of the RM6 5 functions (3 fixed and 2 free).



Advantages of a proven design

RM6 switchgear

- Ensures personal safety:
 - internal arc withstand in conformity with IEC 62271-200
 - visible earthing
 - 3 position switchgear for natural interlocking
 - dependable position indicating devices.
- Is insensitive to the environment:
 - stainless steel sealed tank
 - disconnectable, sealed, metallized fuse chambers.
- Is of approved quality:
 - conforms to national and international standards
 - design and production are certified to ISO 9000 (version 2008)
 - benefits from the experience accumulated from 1,000,000 functional units installed world-wide.
- Respects the environment:
 - end-of-life gas recovery possible
 - ISO 14001 approved production site.
- Is simple and rapid to install:
 - front cable connections at the same height
 - easily fixed to the floor with 4 bolts.
- Is economical:
 - from 1 to 5 functional units, integrated within the same metal enclosure for which insulation and breaking take place in SF6 gas
 - lifetime of 30 years.
- Has maintenance free live parts:
 - in conformity with IEC 62271-1, pressure system, sealed for life.

Range advantages

Compact and scalable, the RM6 range covers all of your requirements



Compact

RM6 Medium Voltage switchgear cubicles are perfectly suited for very simple configuration of 2, 3, 4 or 5 directional connections.

- Choice of “all in one” units integrated in a single metal enclosure
- Cubicles insensitive to climatic conditions
- Optimized dimensions
- Quick installation through floor fixing with four bolts and front cable connection.

Extensible

Just as compact and insensitive to climatic conditions the extensible RM6 is modular to suit your requirements.

The addition of functional unit modules, allows you to build the Medium Voltage switchboard suited to your requirements.

Your organization develops, you build a new building - RM6 adapts with you.

It can be extended on site without handling gases or requiring any special floor preparation to develop your installation simply and in complete safety.

On standard range only : see the exception.

| Possibilities to add cubicle | 1st position | 2nd position | 3rd position | Last position |
|------------------------------|--------------|--------------|--------------|---------------|
| ∅ | RE-x | DE-x | DE-x | LE-x |
| RE-x* | DE-x | DE-x | LE-x | ∅ |

* It is not possible to add RE-x if switchboard with a station DE is in first position

Circuit breakers, for greater safety and lower costs

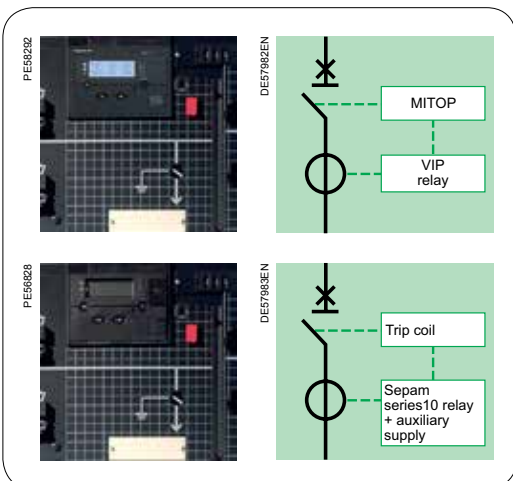

The RM6 range offers 200 A and 630 A circuit breakers to protect both transformers and lines. They are associated with independent protection relays that are selfpowered via current sensors or with auxiliary supply protection relays.

- Greater operating staff safety and improved continuity of service
 - increased protection device co-ordination with the source substation, circuit breaker and the LV fuses
 - rated current is normally high, allowing use of a circuit breaker to provide disconnection
 - the isolating system is insensitive to the environment.
- Simplified switching operations and remote control
 - Reduction of losses thanks to the low value of RI2 (the fuse-switches of a 1000 kVA transformer feeder can dissipate 100 W).
- Reduced maintenance costs no work in progress to replace fuses.

Experience of a world leader

RM6, a world-wide product



Main references

Asia/Middle East

- BSED, Bahrein
- DEWA, Dubaï
- WED, Abu Dhabi
- Tianjin Taifeng Industrial Park, China
- TNB, Malaysia
- China Steel Corporation, Taiwan
- TPC, Taiwan
- SCECO/SEC, Saudi Arabia
- PSB, China

Africa

- Electricité de Mayotte
- EDF Reunion
- Total, Libya
- SONEL, Cameroon
- South Africa

South America/Pacific

- CELESC, Santa Catarina, Brazil
- PETROBRAS, Rio de Janeiro, Brazil
- Guarulhos International Airport
- Sao Paulo, Brazil
- CEMIG, Minas Gerais, Brazil
- EDF, French Guiana
- Tahiti Electricity
- Métro de Mexico, Mexico

Europe

- EDF, France
- Channel tunnel, France
- Iberdrola, Spain
- Compagnie Vaudoise d'électricité
- SEIC, Switzerland
- Electrabel, Belgium
- Union Fenosa, Spain
- ENHER, Spain
- Oslo Energie, Norway
- STOEN, Poland
- Bayerwerke, Germany
- London Electricity, United Kingdom
- Mosenergo, Russia

Oceania

- Eau et Electricité de Calédonie
- New-Caledonia
- Enercal, New-Caledonia
- United Energy, Australia

Protecting the environment

The Schneider Electric's recycling procedure for SF6 based products is subject to rigorous management, and allows each device to be traced through to its final destruction documentation

Schneider Electric is committed to a long term environmental approach. As part of this, the RM6 range has been designed to be environmentally friendly, notably in terms of the product's recyclability. The materials used, both conductors and insulators, are identified and easily separable. At the end of its life, RM6 can be processed, recycled and its materials recovered in conformity with the draft European regulations on the end-of-life of electronic and electrical products, and in particular without any gas being released to the atmosphere nor any polluting fluids being discharged.



The environmental management system adopted by Schneider Electric production sites that produce the RM6 have been assessed and judged to be in conformity with requirements in the ISO 14001 standard.

The RM6 recycling procedure

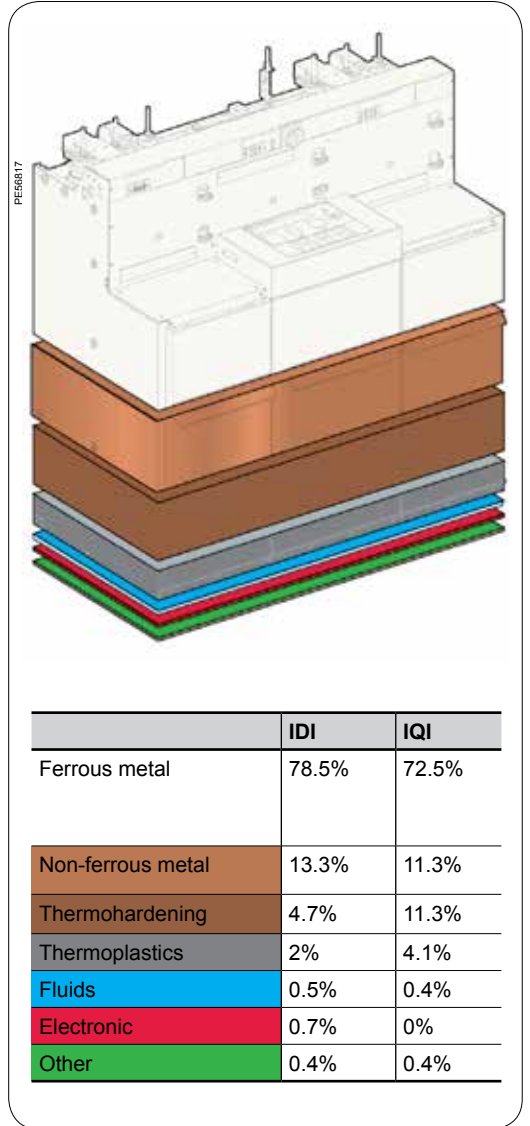

Quality - Standards

IEC standards



RM6 is designed in accordance with the following standards:

General operation conditions for indoor switchgears

IEC 62271-1 (common specifications for high voltage switchgear and controlgear)

- Ambient temperature: class –25°C indoor
 - lower than or equal to 40°C without derating
 - lower than or equal to 35°C on 24 hours average without derating
 - greater than or equal to –25°C.

■ Altitude :

- lower than or equal to 1000 m
- above 1000 m, and up to 2000 m with directed field connectors
- greater than 2000 m: please consult us for specific precaution.
DE-Mt needs voltage derating after 1000m.

Please consider altitude and temperature when selecting Q function fuses.

IEC 62271-200 (A.C. metal enclosed switchgear and controlgear for rated voltage above 1 kV and up to and including 52 kV)

- Switchgear classification: PM class (metallic partitioning)
- Loss of service continuity: LSC2B class for circuit breaker and switch (LSC2A for fuse-switch combinations)
- Internal arc classification: class A-FL up to 20 kA 1 s on request (access restricted to authorized personnel only, for front and lateral access).
- Maximum relative humidity: 95%

Switch-disconnectors

IEC 62271-103 (high voltage switches for rated voltage above 1 kV and less than 52 kV)

- Class M1/E3
 - 100 CO cycles at rated current and 0.7 p.f.
 - 1000 mechanical opening operations.

Circuit breakers: 200 A feeder or 630 A line protection

IEC 62271-100 (high voltage alternating current circuit breakers)

- Class M1/E2
 - 2000 mechanical opening operations,
 - O-3 min.-CO-3 min.-CO cycle at rated short circuit current.

Other applicable standards

IEC 62271-100 (high voltage alternating current circuit breakers)

- Switch-fuse combinations: IEC 62271-105:
alternating current switch-fuse combination.
- Earthing switch: IEC 62271-102:
alternating current disconnectors and earthing switches.
- Electrical relays: IEC 60255.

Quality - Standards

A major plus point

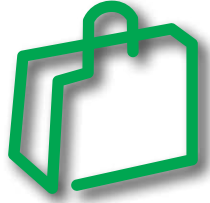

Schneider Electric has integrated a functional organization into each of its units, the main purpose of which is to check quality and ensure the adherence to standards.

This procedure is:

- the same throughout the different departments
- recognized by numerous approved customers and organizations.

Above all, it is our strict application of this functional organization that has enabled us to obtain the recognition of an independent organization, the French Association for Quality Assurance (Association Française pour l'Assurance Qualité, or (AFAQ).

The RM6 design and production quality system has been certified as being in conformity with the requirements of the ISO 9001: 2008 quality assurance model.

Rigorous, systematic checks

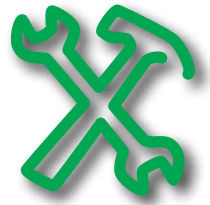

During the manufacture of each RM6, it undergoes systematic routine tests, the aim of which is to check quality and conformity:

- tightness check
- filling pressure check
- opening and closing speed measurement
- operating torque measurement
- partial discharge check
- dielectric check
- conformity with drawings and diagrams.

The quality control department records and signs the results obtained on the test certificate for each device.

There is "zero" SF6 emission during the gas filling and tightness control process.



RM6 platform of test



wide choice

wide choice

The RM6 range brings together all the MV functions enabling connection, power supply and protection of transformers; protection of lines and now production of private MV/LV substations.

Contents

| | |
|-----------------------------|-----|
| RM6 switchgear description | B-2 |
| Safety of people | B-3 |
| RM6 for Marine applications | B-5 |
| A wide choice of functions | B-6 |



RM6 switchgear description

RM6 switchgear comprises 2, 3, 4 or 5 directionnal connections integrated, low dimension functional units.

This self-contained, totally insulated unit comprises:

- a stainless steel, gas-tight metal enclosure, sealed for life, which groups together the live parts, switch-disconnector, earthing switch, fuse switch or the circuit breaker
- one to four cable compartments with interfaces for connection to the network or to the transformer
- a low voltage cabinet
- an electrical operating mechanism cabinet
- a fuse chamber compartment for fused switch-disconnectors or fuse switches.

The performance characteristics obtained by the RM6 meet the definition of a "sealed pressure system" laid down in the IEC recommendations. The switch-disconnector and the earthing switch offer the operator all necessary usage guarantees:

Tightness

The enclosure is filled with SF6 at a 0.2 bar gauge pressure. It is sealed for life after filling. Its tightness, which is systematically checked at the factory, gives the switchgear an expected lifetime of 30 years. No maintenance of live parts is necessary with the RM6 breaking.

Switch-disconnector

Electrical arc extinction is obtained using the SF6 puffer technique.

Circuit breaker

Electrical arc extinction is obtained using the rotating arc technique plus SF6 auto-expansion, allowing breaking of all currents up to the short-circuit current.



A range that is extensible on site

When harsh climatic conditions or environmental restrictions make it necessary to use compact switchgear, but the foreseeable evolution of the power distribution network makes it necessary to provide for future changes, RM6 offers a range of extensible switchgear.

The addition of one or more functional units can be carried out by simply adding modules that are connected to each other at busbar level by directed field bushings.

This very simple operation can be carried out on-site:

- without handling any gas
- without any special tooling
- without any particular preparation of the floor.

The only technical limitation to the evolution of an extensible RM6 switchboard is therefore the rated current acceptable by the busbar: 630 A at 40°C.



Insensitivity to the environment

Complete insulation

- **A metal enclosure** made of stainless steel, which is unpainted and gas-tight (IP67), contains the live parts of the switchgear and the busbars.
- **Three sealed fuse chambers**, which are disconnectable and metallized on the outside, insulate the fuses from dust, humidity...
- **Metallization of the fuse chambers and directed field terminal connectors** confines the electrical field in the solid insulation.

Taken together, the above elements provide the RM6 with genuine total insulation which makes the switchgear completely insensitive to environmental conditions, dust, extreme humidity, temporary soaking. (IP67: immersion for 30 minutes, as laid down in IEC standard 60529, § 14.2.7).



Safety of people

Switchgear

Switch-disconnectors and circuit breakers have similar architecture:

- **a moving contact assembly with 3 stable positions** (closed, open and earthed) moves vertically (see sketch). Its design makes simultaneous closing of the switch or circuit breaker and the earthing switch impossible.
- **the earthing switch** has a short-circuit making capacity, as required by the standards.
- the RM6 combines both the isolating and interrupting function.
- the earth collector has the correct dimensions for the network.
- access to the cable compartment can be interlocked with the earthing switch and/or the switch or circuit breaker.



3 stable position switch

Internal arc withstand

The robust, reliable and environmentally insensitive design of the RM6 makes it highly improbable that a fault will appear inside the switchgear. Nevertheless, in order to ensure maximum personal safety, the RM6 is designed to withstand an internal arc supplied by a rated short-circuit current for 1 second, without any danger to the operator.

Accidental overpressure due to an internal arc is limited by the opening of the safety valve, at the bottom of the metal enclosure. The internal arc withstand of the tank is of 20 kA 1 s. With the option of the internal arc in cable compartment, the RM6 cubicle has an internal arc withstand up to 20 kA 1 s, which meets all the criteria of IAC class A-FL as defined by IEC 62271-200 standard, appendix A. The gas is released to the rear or to the bottom of the RM6 without affecting conditions in the front. When the gas is exhausted to the rear, the maximum internal arc withstand is of 16 kA 1 s. In case the gas is exhausted to the bottom, the internal arc withstand is up to 20 kA 1 s.



Reliable operating mechanisms

The electrical and mechanical operating mechanisms are located behind a front plate displaying the mimic diagram of the switchgear status (closed, open, earthed):

- **closing:** the moving contact assembly is manipulated by means of a fast-acting operating mechanism. Outside these manipulations, no energy is stored. For the circuit breaker and the fuse-switch combination, the opening mechanism is charged in the same movement as the closing of the contacts.
- **opening:** opening of the switch is carried out using the same fast-acting mechanism, manipulated in the opposite direction. For the circuit breaker and fuse-switch combination, opening is actuated by:
 - a pushbutton
 - a fault.
- **earthing:** a specific operating shaft closes and opens the earthing contacts. The hole providing access to the shaft is blocked by a cover which can be opened if the switch or circuit breaker is open, and remains locked when it is closed.
- **switchgear status indicators:** are placed directly on the moving contact assembly operating shafts. They give a definite indication of the position of the switchgear (attachment A of IEC standard 62271-102).
- **operating lever:** this is designed with an anti-reflex device which prevents any attempt to immediately reopen the switch-disconnector or the earthing switch after closing.
- **padlocking facilities:** 1 to 3 padlocks can be used to prevent:
 - access to the switch or circuit breaker operating shaft
 - access to the earthing switch operating shaft
 - operation of the opening pushbutton.



Earthing display

Earthing switch closed position indicators: these are located on the upper part of the RM6. They can be seen through the transparent earthing covers, when the earthing switch is closed.

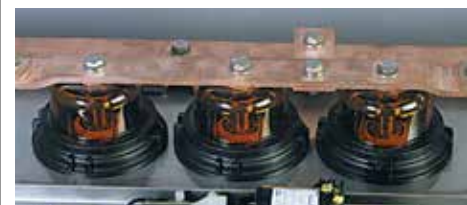

Safety of people

Operating safety

Cable insulation test

In order to test cable insulation or look for faults, it is possible to inject a direct voltage of up to 42 kVdc for 15 minutes through the cables via the RM6, without disconnecting the connecting devices.

The earthing switch is closed and the moving earthing connection is opened in order to inject the voltage via the "earthing covers". This system, a built-in feature of the RM6, requires the use of injection fingers (supplied as an option). The moving contacts of the earthing switch shall be visible in the closed position through transparent covers.



Arc short-circuiting

RM6 Arc short-circuiting device : Arc Killer, safety of persons, environment friendly

Transforms an internal arc in the tank into short-circuit.

Prevent overpressure inside the gas tank in case of internal arc fault (no gaz outside the tank). Available on switch function (I). No Extensible or not on a side of extension.

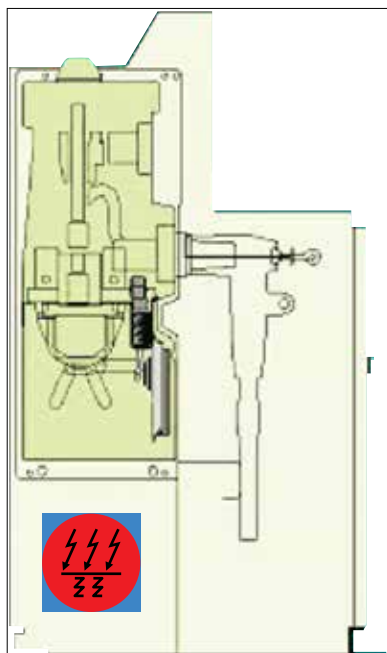

Voltage indicator lamps

A device (supplied as an option) on all functional units makes it possible to check the presence (or absence) of voltage in the cables. Two types of indicator can be proposed according to network operating habits:

- a device with built-lamps, of the VPIS type (Voltage Presence Indicating System) complying with standard IEC 62271-206.



- or a system with separate luminous modules, of the VDS type (Voltage Detection System) complying with standard IEC 61243-5.



RM6 for Marine applications

PE6007



RM6 Marine: benefits of the MV loop adapted to the boat

The RM6 has the DNV type approval certificate for Marine applications.

A MV loop configuration offers significant advantages:

- main MV switchboard smaller (only two cells to feed a MV loop)
 - length of MV cables reduced (shortening average ratio > 30% for the configuration)
 - the maintainability and availability of the network are also improved.
- Actually:
- a failed cable section on the MV loop can be disconnected
 - an automatic reconfiguration of the MV loop after a fault detection can be achieved.

Safety for personal

If RM6 is equipped with special "filter" LRU (internal arc Reduction Unit), internal arc classification is AFLR 20 kA 1s defined in the standard IEC 62271-200.

Resistance to vibrations

- Conform to IACS marine standards
- RM6 has a very low centre of gravity.

Resistance to vibrations

Resist to aggressive atmosphere.

Some Marine references

- Aker Yards:
 - NCL Cruise Liner
 - Genesis 1 & 2.
- Meyer Werft:
 - Aida ships
 - Norwegian Gem
 - Norwegian Pearl
 - Pride of Hawaii,
 - Norwegian Jewel
 - Jewel of the seas...



INTERNATIONAL ASSOCIATION OF CLASSIFICATION SOCIETIES LTD.

Example of a cruise liner architecture

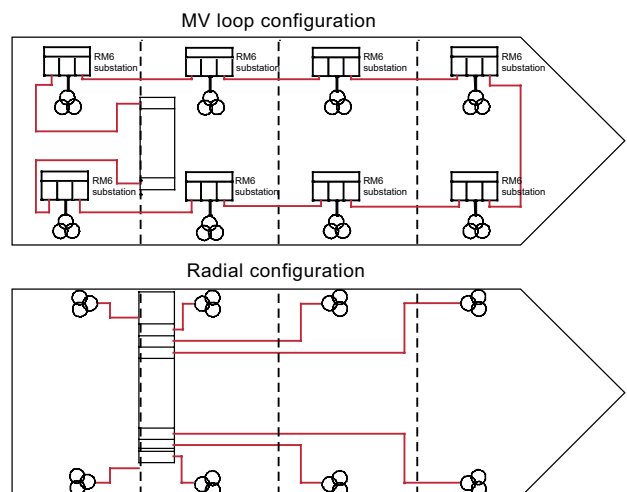
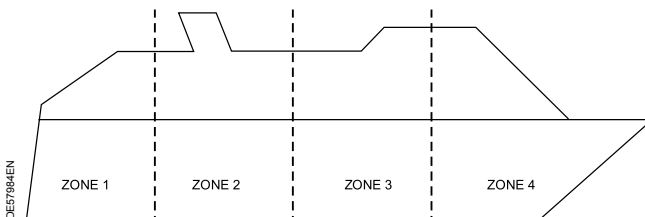

A wide choice of functions

RM6 range functions

The RM6 range brings together all of the MV functions enabling:

- connection, power supply and protection of transformers on a radial or open-ring network via **200 A circuit breakers** with an independent protection chain or via **combined fuse-switches**
- protection of lines by a **630 A circuit breaker**
- and now production of **private MV/LV substations** with MV metering.

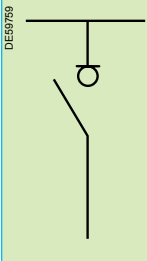
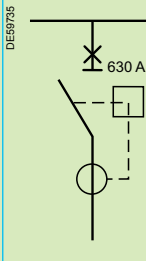
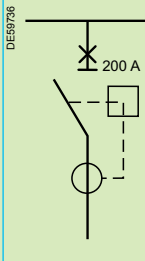
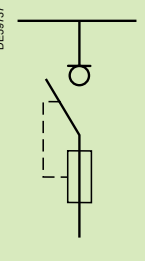
| Function | Network switch | Line feeder | Transformer feeder | |
|----------------------|--|--|---|--|
| Functional unit | I | B | D | Q |
| Device | Circuit breaker | 630 A circuit breaker | 200 A circuit breaker | Combined fuse-switch |
| Single line diagrams |  |  |  |  |

Device designation

| Type of tank | Multifunction configurations * | | | | Unit configurations |
|--|---|------|------------------|------|---|
| NE: non-extensible RE: extensible to the right LE: extensible to the left DE: extensible module to the right or left (one function) | I B D Q | I | I B D Q | I | I B D Q IC BC O Mt |
| | N° 4 | N° 3 | N° 2 | N° 1 | N° 1 |
| Examples of designation | RM6 NE-DIDI RM6 RE-IDI RM6 NE-IQI | | | | RM6 DE-I RM6 NE-D RM6 DE-Mt |

* Refer to the table on page 68 for the choice of different combinations

A wide choice of functions

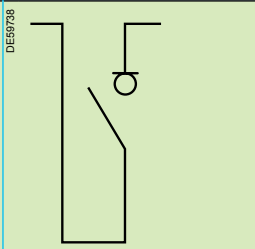
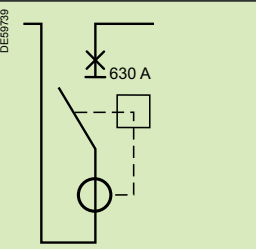
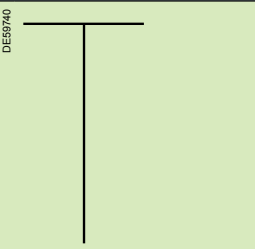
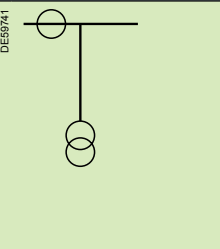
| Network coupling | | Cable connection | MV metering |
|---|---|---|--|
| IC | BC | O | Mt |
| Switch | 630 A circuit breaker | | |
|  <p>DE69738</p> |  <p>DE69739</p> |  <p>DE69740</p> |  <p>DE69741</p> |



characteristics

characteristics

Detailed characteristics for each function, combinations...

Contents

| | |
|---|-------------|
| Main characteristics | C-2 |
| Detailed characteristics for each function | C-3 |
| Medium Voltage metering | C-11 |
| RM6 Free Combination | C-12 |
| RM6 5 functions | C-14 |
| Circuit breaker function | |
| Protection relays selection | C-15 |
| Transformer protection by circuit breaker | |
| VIP 40, VIP 45 | C-16 |
| General protection by circuit breaker | |
| VIP 400 & VIP 410 | C-17 |
| VIP integrated system | C-18 |
| Line and transformer protection by circuit breaker | |
| Sepam series 10 | C-19 |
| Core balance CTs CSH120, CSH200 | C-20 |
| Transformer protection by fuse-switches | C-21 |

Main characteristics



Electrical characteristics

| | | | | |
|------------------------------------|---|----------|------|-----------|
| Rated voltage | Ur (kV) | 12 | 17.5 | 24 |
| Frequency | f (Hz) | 50 or 60 | | |
| Insulation level | | | | |
| Industrial frequency 50 Hz 1 mn | Insulation ⁽¹⁾ Up (kV rms) | 28 | 38 | 50 |
| | Isolation ⁽²⁾ Ud (kV rms) | 32 | 45 | 60 |
| Impulse 1.2/50 μ s | Insulation ⁽¹⁾ Up (kV peak) | 75 | 95 | 125 |
| | Insulation ⁽¹⁾ Up (kV peak) | 85 | 110 | 145 |
| Tank internal arc withstand | | | | 20 kA 1 s |

(1) Phase-to-phase, phase-to-earth

(2) Across the isolating distance

Climatic conditions

| | (°C) | 40 | 45 | 50 | 55 | 60 |
|---|---------------|-----|-----|-----|-----|-----|
| Busbars 630 A | Ir (A) | 630 | 575 | 515 | 460 | 425 |
| Busbars 400 A | Ir (A) | 400 | 400 | 400 | 355 | |
| Functions: I, O, B (with bushing type C) | (A) | 630 | 575 | 515 | 460 | 425 |
| Function D (with bushing type B or C) | (A) | 200 | 200 | 200 | 200 | 200 |
| Function Q | (A) | (3) | (4) | (4) | (4) | (4) |

(3) Depends on fuse selection

(4) Please consult us



Global options

- Manometer or pressure switch
- Additional earth busbar in cable compartment
- Internal arc cable box 20 kA 1 s for I, D or B functions.

Accessories

- Raising plinth
- Set of 3 MV fuses Fusarc CF
- Phase comparator
- Test box for circuit breaker relay (VAP6)
- Additional operating handle.

Additional instructions:

Installation and civil Engineering instructions.

Option for operation

- Voltage indicator
- VPIS
 - VDS.

Connectors and adaptaters for RM6

- Connectors for 630 A (1 set = 1 function)
- Connectors for 400 A (1 set = 1 function)
- Connectors for 250 A (1 set = 1 function).

Protection index

- Tank with HV parts: IP67
- Low voltage control compartment: IP3X
- Front face + mechanism: IP3X
- Cable compartment: IP2XC
- Protection against mechanical impact: IK07.

Detailed characteristics for each function

Network points with switch-disconnector (I function)

| | | | | | | | | |
|--|-----------------------|--------------|------|--------|--------|--------|-----|--------|
| Rated voltage | Ur | (kV) | 12 | 17.5 | 24 | 24 | 24 | 24 |
| Short-time withstand current | Ik | (kA rms) | 25 | 21 | 12.5 | 16 | 16 | 20 |
| | tk | Duration (s) | 1 | 1 or 3 | 1 | 1 | 1 | 1 or 3 |
| Rated current busbars | Ir | (A) | 630 | 630 | 400 | 400 | 630 | 630 |
| Network switch (I function) | | | | | | | | |
| Rated current | Ir | (A) | 630 | 630 | 400 | 400 | 630 | 630 |
| Breaking capacity | Active load | Iload | (A) | 630 | 630 | 400 | 400 | 630 |
| | Earth fault | Ief1 | (A) | 320 | 320 | 320 | 320 | 320 |
| | Cable charging | Icc | (A) | 110 | 110 | 110 | 110 | 110 |
| Making capacity of switch and earthing switches | I_{ma} | (kA peak) | 62.5 | 52.5 | 31.25 | 40 | 40 | 50 |
| Bushing | | | C | C | B or C | B or C | C | C |

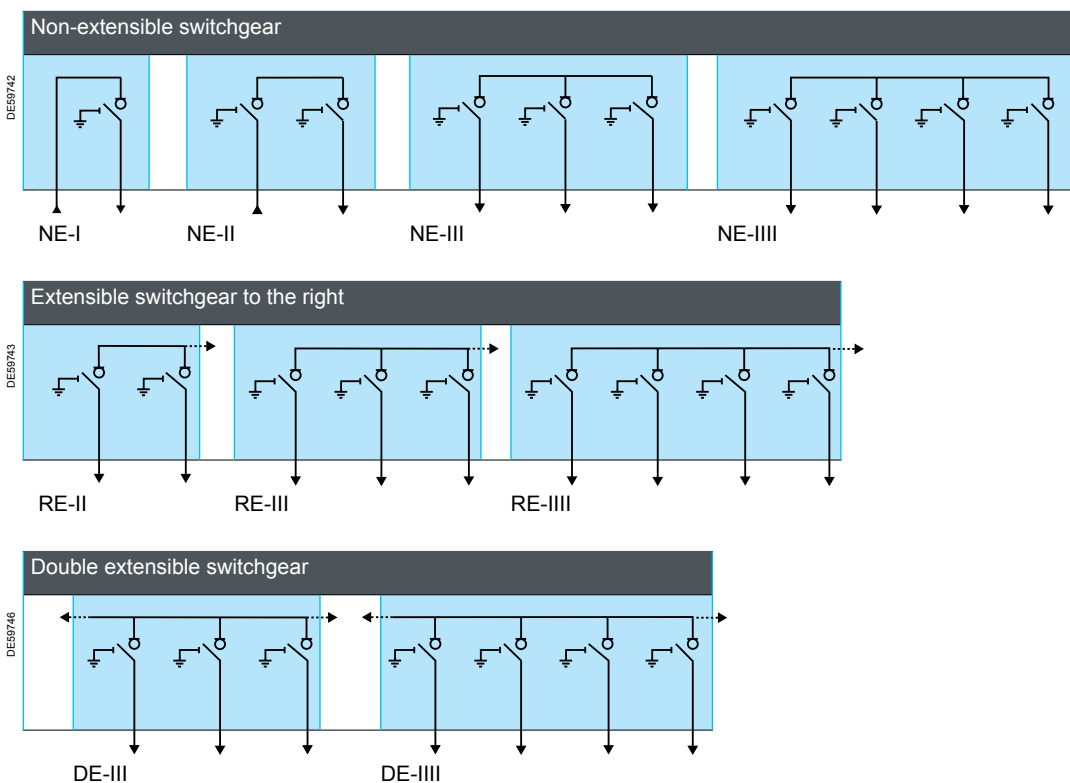

Accessories and options (I function)

Remote operation

Motorization including auxiliary contacts (LBSw 2 NO - 2 NC and ESw 1 O/C).

Auxiliary contacts alone

For main switch position indication LBSw 2 NO - 2 NC and ESw 1 O/C (this option is included in remote operation option).

Front door of cable connection compartment

- Bolted
- Removable with ESw interlocking
- Removable with ESw interlocking and LBSw interlocking.

Self-powered fault passage and load current indicators

- Flair 21D
- Flair 22D

- Flair 23D
- Flair 23DM
- Amp 21D.

Key locking devices

- Type R1
- Type R2.

Arc Killer: RM6 arc short-circuiting device.

Transforms an internal arc into short-circuit
Available for Non Extensible cubicle or not on a side of extension because arc Killer block is not compatible with the extension bushing.
See decision tree (or Elonet) for applicable offers.

Metallic VT in some RM6 cubicles

Detailed characteristics for each function

Network points with 630 A disconnecting circuit breaker (B function)

| | | | | | | |
|--|----------------|--------------|------|--------|-----|--------|
| Rated voltage | Ur | (kV) | 12 | 17.5 | 24 | 24 |
| Short-time withstand current | Ik | (kA rms) | 25 | 21 | 16 | 20 |
| | tk | Duration (s) | 1 | 1 or 3 | 1 | 1 or 3 |
| Rated current busbars | Ir | (A) | 630 | 630 | 630 | 630 |
| Network switch (I function) | | | | | | |
| Rated current | Ir | (A) | 630 | 630 | 630 | 630 |
| Breaking capacity | Active load | Iload | (A) | 630 | 630 | 630 |
| | Earth fault | Ief1 | (A) | 320 | 320 | 320 |
| | Cable charging | Icc | (A) | 110 | 110 | 110 |
| Making capacity of switch and earthing switches | Ima | (kA peak) | 62.5 | 52.5 | 40 | 50 |
| Bushing | | | C | C | C | C |
| Line protection feeder (B function) | | | | | | |
| Rated current | Ir | (A) | 630 | 630 | 630 | 630 |
| Short-circuit breaking capacity | Isc | (kA) | 25 | 21 | 16 | 20 |
| Making capacity | Ima | (kA peak) | 62.5 | 52.5 | 40 | 50 |
| Bushing | | | C | C | C | C |

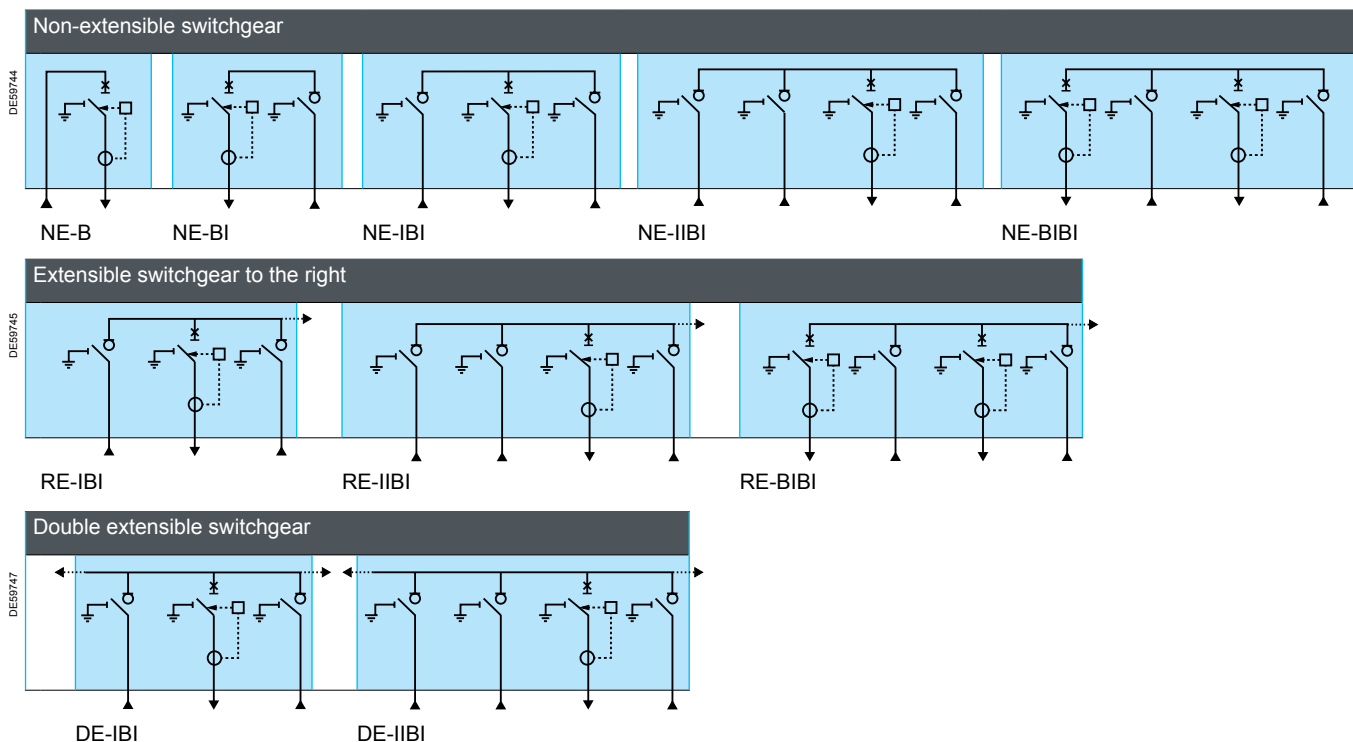

Accessories and options (B function)

Remote operation

Motorization including shunt trip coil and auxiliary contacts circuit breaker (CB 2 NO - 2 NC and ESw 1 O/C).

Auxiliary contacts alone

For circuit breaker position indication CB 2 NO - 2 NC and ESw 1 O/C (this option is included in remote operation option).

Front door of cable connection compartment

- Bolted
- Removable with ESw interlocking
- Removable with ESw interlocking and CB interlocking.

Shunt trip coil for external tripping

- 24 Vdc
- 48/60 Vdc
- 120 Vac
- 110/125 Vdc - 220 Vac
- 220 Vdc/380 Vac.

Undervoltage coil

- 24 Vdc
- 48 Vdc
- 125 Vdc
- 110-230 Vac.

Protection relay for CB transformer protection
(VIP 400, 410 or Sepam series 10)*

Forbidden closing under fault 1 NC

Auxiliary contact D or B tripping

Key locking devices

- Type R1
- Type R2.

* In case of such relays, ring-core CTs are mandatory

Detailed characteristics for each function

Transformer feeder 200 A with disconnecting circuit breaker (D function)

| | | | | | | | | | |
|-------------------------------------|-----------|--------------|-----|--------|------|-----|------|-----|--------|
| Rated voltage | Ur | (kV) | 12 | 17.5 | 24 | 24 | 24 | 24 | 24 |
| Short-time withstand current | Ik | (kA rms) | 25 | 21 | 12.5 | 16 | 12.5 | 16 | 20 |
| | | Duration (s) | 1 | 1 or 3 | 1 | 1 | 1 | 1 | 1 or 3 |
| Rated current busbars | Ir | (A) | 630 | 630 | 400 | 400 | 630 | 630 | 630 |

Network switch (I function)

| | | | | | | | | | | |
|--|-------------|--------------|------|------|--------|--------|-------|-----|-----|-----|
| Rated current | Ir | (A) | 630 | 630 | 400 | 400 | 630 | 630 | 630 | |
| Breaking capacity | Active load | Iload | (A) | 630 | 630 | 400 | 400 | 630 | 630 | 630 |
| | | Ief1 | (A) | 320 | 320 | 320 | 320 | 320 | 320 | 320 |
| | | Icc | (A) | 110 | 110 | 110 | 110 | 110 | 110 | 110 |
| Making capacity of switch and earthing switches | Ima | (kA peak) | 62.5 | 52.5 | 31.25 | 40 | 31.25 | 40 | 50 | |
| Bushing | | | C | C | B or C | B or C | C | C | C | |

Transformer feeder by disconnecting circuit breaker (D function)

| | | | | | | | | | |
|--|------------|-----------|------|------|-------|--------|-------|--------|-----|
| Rated current | Ir | (A) | 200 | 200 | 200 | 200 | 200 | 200 | 200 |
| No-load transformer breaking capacity | I3 | (A) | 16 | 16 | 16 | 16 | 16 | 16 | 16 |
| Short-circuit breaking capacity | Isc | (kA) | 25 | 21 | 12.5 | 16 | 12.5 | 16 | 20 |
| Making capacity | Ima | (kA peak) | 62.5 | 52.5 | 31.25 | 40 | 31.25 | 40 | 50 |
| Bushing | | | C | C | A | B or C | A | B or C | C |

Non-extensible switchgear

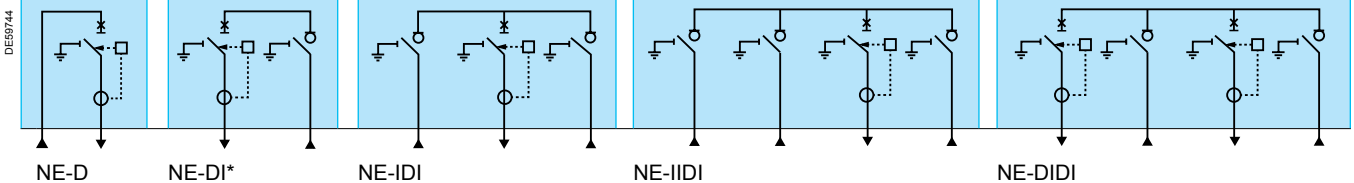

Extensible switchgear to the right

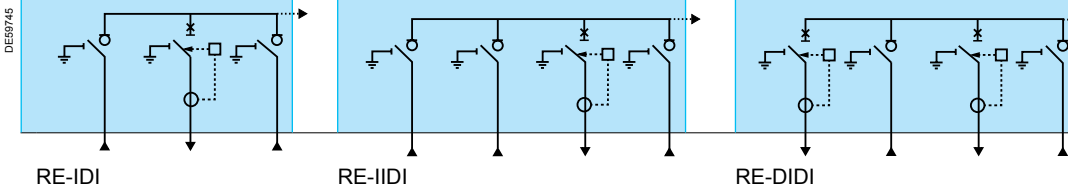

Double extensible switchgear

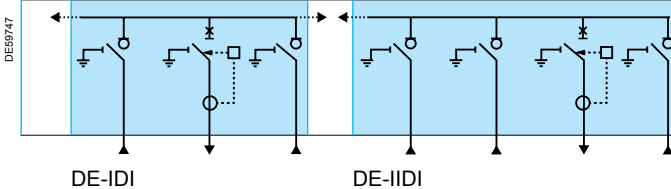

* For NE-DI, the rated current is of 200 A for the I and D functions.

Accessories and options (D function)

Remote operation

Motorization including shunt trip coil and auxiliary contacts circuit breaker (CB 2 NO - 2 NC and ESw 1 O/C).

Auxiliary contacts alone

For circuit breaker position indication CB 2 NO - 2 NC and ESw 1 O/C (this option is included in remote operation option).

Front door of cable connection compartment

- Bolted
- Removable with ESw interlocking
- Removable with ESw interlocking and CB interlocking.

Shunt trip coil for external tripping

- 24 Vdc
- 48/60 Vdc
- 120 Vac
- 110/125 Vdc - 220 Vac
- 220 Vdc/380 Vac.

Undervoltage coil

- 24 Vdc
- 48 Vdc
- 125 Vdc
- 110-230 Vac.

Protection relay for CB transformer protection

(VIP 40, 45, 400, 410 or Sepam series 10)

Forbidden closing under fault 1 NC

Auxiliary contact D or B tripping

Key locking devices

- Type R6
- Type R7
- Type R8.

Detailed characteristics for each function

Transformer feeder with fuse-switch combinations (Q function)

| | | | | | | | | | |
|--|----------------|--------------|------|------|--------|--------|--------|-----|--------|
| Rated voltage | Ur | (kV) | 12 | 12 | 17.5 | 24 | 24 | 24 | 24 |
| Rated current busbars | Ir | (A) | 630 | 630 | 630 | 400 | 400 | 630 | 630 |
| Network switch (I function) | | | | | | | | | |
| Rated current | Ir | (A) | 630 | 630 | 630 | 400 | 400 | 630 | 630 |
| Breaking capacity | Active load | Iload | (A) | 630 | 630 | 630 | 400 | 400 | 630 |
| | Earth fault | Ief1 | (A) | 320 | 320 | 320 | 320 | 320 | 320 |
| | Cable charging | Icc | (A) | 110 | 110 | 110 | 110 | 110 | 110 |
| Short-time withstand current | Ik | (kA rms) | 21 | 25 | 21 | 12.5 | 16 | 16 | 20 |
| | tk | Duration (s) | 1 | 1 | 1 or 3 | 1 | 1 | 1 | 1 or 3 |
| Making capacity of switch and earthing switches | Ima | (kA peak) | 52.5 | 62.5 | 52.5 | 31.25 | 40 | 40 | 50 |
| Bushing | | | C | C | C | B or C | B or C | C | C |
| Transformer feeder with fuse-switch protection (Q function) | | | | | | | | | |
| Rated current | Ir | (A) | 200 | 200 | 200 | 200 | 200 | 200 | 200 |
| No-load transformer breaking capacity | I3 | (A) | 16 | 16 | 16 | 16 | 16 | 16 | 16 |
| Short-circuit breaking capacity | Isc | (kA) | 21 | 25 | 21 | 12.5 | 16 | 16 | 20 |
| Making capacity | Ima | (kA peak) | 52.5 | 62.5 | 52.5 | 31.25 | 40 | 40 | 50 |
| Bushing | | | A | A | A | A | A | A | A |

Please consider altitude and temperature when selecting Q function fuses.

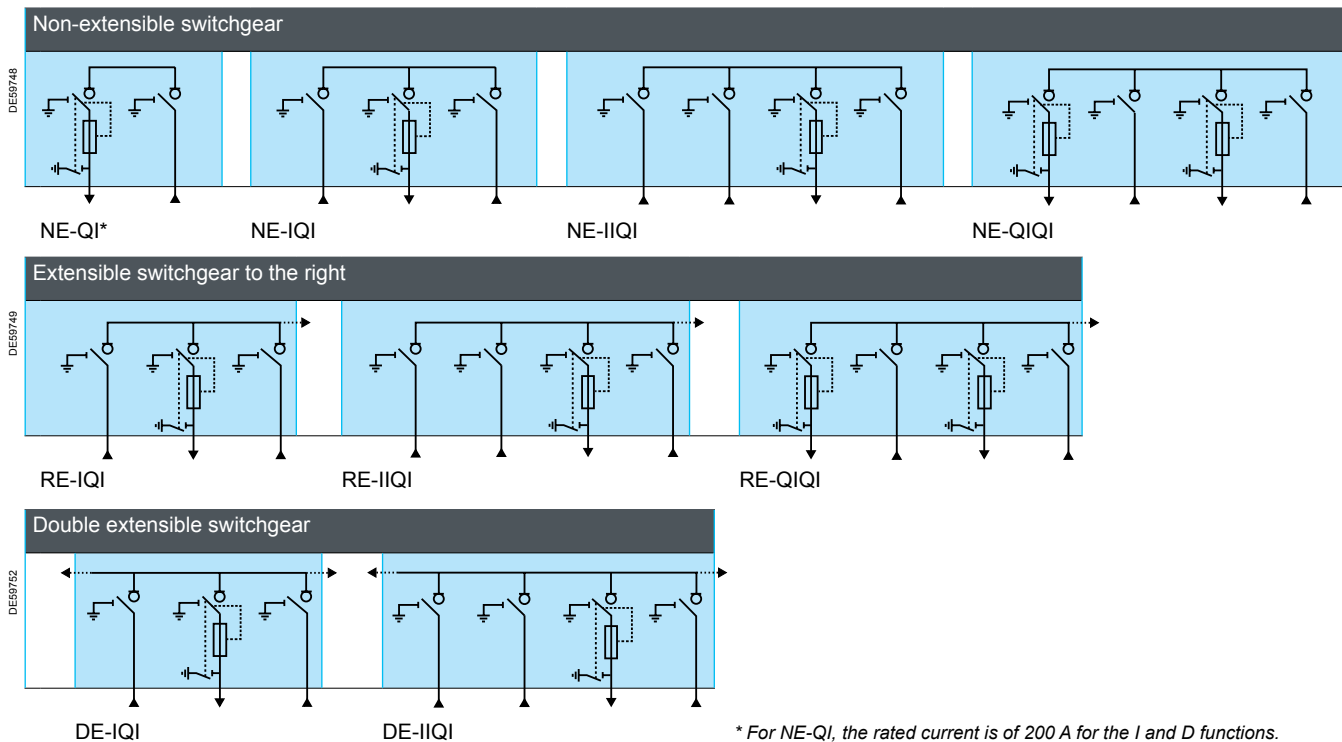

* For NE-QI, the rated current is of 200 A for the I and D functions.

Accessories and options (Q function)

Remote operation

Motorization including auxiliary contacts fuse-switch combinations (2 NO - 2 NC).

Auxiliary contacts alone

For fuse-switch combinations position indication LBSw 2 NO - 2 NC (this option is included in remote operation option).

Auxiliary contact for fuses blown

Shunt trip coil for external tripping

- 24 Vdc
- 48/60 Vdc
- 120 Vac

- 110/125 Vdc - 220 Vac
- 220 Vdc/380 Vac.

Undervoltage coil

- 24 Vdc
- 48 Vdc
- 125 Vdc
- 110-230 Vac.

Key locking devices

- Type R6
- Type R7
- Type R8.

Detailed characteristics for each function

Extensible modules (DE-I function)

| | | | | | | | | |
|--|----------------|--------------|------|--------|--------|--------|-----|--------|
| Rated voltage | Ur | (kV) | 12 | 17.5 | 24 | 24 | 24 | 24 |
| Short-time withstand current | Ik | (kA rms) | 25 | 21 | 12.5 | 16 | 16 | 20 |
| | tk | Duration (s) | 1 | 1 or 3 | 1 | 1 | 1 | 1 or 3 |
| Rated current busbars | Ir | (A) | 630 | 630 | 630 | 630 | 630 | 630 |
| Network switch (DE-I function) | | | | | | | | |
| Rated current | Ir | (A) | 630 | 630 | 400 | 400 | 630 | 630 |
| Breaking capacity | Active load | Iload | (A) | 630 | 630 | 400 | 400 | 630 |
| | Earth fault | Ief1 | (A) | 320 | 320 | 320 | 320 | 320 |
| | Cable charging | Icc | (A) | 110 | 110 | 110 | 110 | 110 |
| Making capacity of switch and earthing switches | Ima | (kA peak) | 62.5 | 52.5 | 31.25 | 40 | 40 | 50 |
| Bushing | | | C | C | B or C | B or C | C | C |

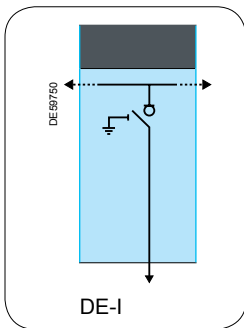

Accessories or options (I function)

Remote operation

Motorization including auxiliary contacts (LBSw 2 NO - 2 NC and ESw 1 O/C).

Auxiliary contacts alone

For main switch position indication LBSw 2 NO - 2 NC and ESw 1 O/C (this option is included in remote operation option).

Front door of cable connection compartment

- Bolted
- Removable with ESw interlocking
- Removable with ESw interlocking and LBSw interlocking.

Self-powered fault passage and load current indicators

- Flair 21D
- Flair 22D
- Flair 23D
- Flair 23DM
- Amp 21D.

Key locking devices

- Type R1
- Type R2.

Network points with 630 A disconnecting circuit breaker (DE-B function)

| | | | | | | |
|--|------------|--------------|------|--------|-----|--------|
| Rated voltage | Ur | (kV) | 12 | 17.5 | 24 | 24 |
| Short-time withstand current | Ik | (kA rms) | 25 | 21 | 16 | 20 |
| | tk | Duration (s) | 1 | 1 or 3 | 1 | 1 or 3 |
| Rated current busbars | Ir | (A) | 630 | 630 | 630 | 630 |
| Network disconnecting circuit breaker (DE-B function) | | | | | | |
| Rated current | Ir | (A) | 630 | 630 | 630 | 630 |
| Short-circuit breaking capacity | Isc | (kA) | 25 | 21 | 16 | 20 |
| Making capacity | Ima | (kA peak) | 62.5 | 52.5 | 40 | 50 |
| Bushing | | | C | C | C | C |

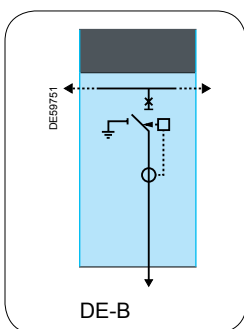

Accessories and options

Remote operation

Motorization including shunt trip coil and auxiliary contacts circuit breaker (CB 2 NO - 2 NC and ESw 1 O/C).

Auxiliary contacts alone

For circuit breaker position indication CB 2 NO - 2 NC and ESw 1 O/C (this option is included in remote operation option).

Front door of cable connection compartment

- Bolted
- Removable with ESw interlocking
- Removable with ESw interlocking and CB interlocking.

Shunt trip coil for external tripping

- 24 Vdc
- 48/60 Vdc

- 120 Vac
- 110/125 Vdc - 220 Vac
- 220 Vdc/380 Vac.

Undervoltage coil

- 24 Vdc
- 48 Vdc
- 125 Vdc
- 110-230 Vac.

Protection relay for CB transformer protection (VIP 40, 400 or Sepam series 10)

Forbidden closing under fault 1 NC

Auxiliary contact D or B tripping

Key locking devices

- Type R1
- Type R2.

Detailed characteristics for each function

Transformer feeder 200 A with disconnecting circuit breaker (DE-D function)

| | | | | | | | |
|--|-----------------|--------------|------|--------|-------|--------|--------|
| Rated voltage | Ur | (kV) | 12 | 17.5 | 24 | 24 | 24 |
| Short-time withstand current | Ik | (kA rms) | 25 | 21 | 12.5 | 16 | 20 |
| | tk | Duration (s) | 1 | 1 or 3 | 1 | 1 | 1 or 3 |
| Rated current busbars | Ir | (A) | 630 | 630 | 400 | 400 | 630 |
| 200 A disconnecting circuit breaker (DE-D function) | | | | | | | |
| Rated current | Ir | (A) | 200 | 200 | 200 | 200 | 200 |
| No-load transformer breaking capacity | I3 | (A) | 16 | 16 | 16 | 16 | 16 |
| Short-circuit breaking capacity | Isc | (kA) | 25 | 21 | 12.5 | 16 | 20 |
| Making capacity | I _{ma} | (kA peak) | 62.5 | 52.5 | 31.25 | 40 | 50 |
| Bushing | | | C | C | A | B or C | C |

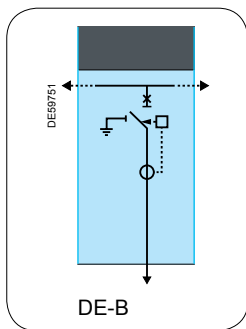

Accessories and options

Remote operation

Motorization including shunt trip coil and auxiliary contacts circuit breaker (CB 2 NO - 2 NC and ESw 1 O/C).

Auxiliary contacts alone

For circuit breaker position indication CB 2 NO - 2 NC and ESw 1 O/C (this option is included in remote operation option).

Front door of cable connection compartment

- Bolted
- Removable with ESw interlocking
- Removable with ESw interlocking and CB interlocking.

Shunt trip coil for external tripping

- 24 Vdc
- 48/60 Vdc
- 120 Vac

- 110/125 Vdc - 220 Vac
- 220 Vdc/380 Vac.

Undervoltage coil

- 24 Vdc
- 48 Vdc
- 125 Vdc
- 110-230 Vac.

Protection relay for CB transformer protection (VIP 40, 45, 400 or Sepam series 10)

Forbidden closing under fault 1 NC

Auxiliary contact D or B tripping

Key locking devices

- Type R6
- Type R7
- Type R8.

Extensible modules (DE-Q function)

| | | | | | | | | |
|--------------------------------------|-----------------|-----------|------|------|------|-------|-----|-----|
| Rated voltage | Ur | (kV) | 12 | 12 | 17.5 | 24 | 24 | 24 |
| Rated current busbars | Ir | (A) | 630 | 630 | 630 | 630 | 630 | 630 |
| Fuses (DE-Q function) | | | | | | | | |
| Rated current | Ir | (A) | 200 | 200 | 200 | 200 | 200 | 200 |
| Off-load transformer laking capacity | I3 | (A) | 16 | 16 | 16 | 16 | 16 | 16 |
| Short-circuit breaking capacity | Isc | (kA) | 21 | 25 | 21 | 12.5 | 16 | 20 |
| Making capacity | I _{ma} | (kA peak) | 52.5 | 62.5 | 52.5 | 31.25 | 40 | 50 |
| Bushing | | | A | A | A | A | A | A |

Please consider altitude and temperature when selecting Q function fuses.

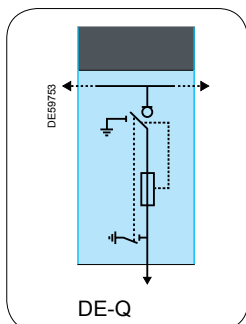

Accessories and options

Remote operation

Motorization including auxiliary contacts fuse-switch combinations (2 NO - 2 NC).

Auxiliary contacts alone

For fuse-switch combinations position indication LBSw 2 NO - 2 NC (this option is included in remote operation option).

Auxiliary contact for fuses blown

Shunt trip coil for external tripping

- 24 Vdc
- 48/60 Vdc
- 120 Vac

- 110/125 Vdc - 220 Vac
- 220 Vdc/380 Vac.

Undervoltage coil

- 24 Vdc
- 48 Vdc
- 125 Vdc
- 110-230 Vac.

Key locking devices

- Type R6
- Type R7
- Type R8.

Detailed characteristics for each function

Bus coupler by switch-disconnector (DE-IC function)

| | | | | | | |
|--|----------------|--------------|------|--------|-----|--------|
| Rated voltage | Ur | (kV) | 12 | 17.5 | 24 | 24 |
| Short-time withstand current | Ik | (kA rms) | 25 | 21 | 16 | 20 |
| | tk | Duration (s) | 1 | 1 or 3 | 1 | 1 or 3 |
| Rated current busbars | Ir | (A) | 630 | 630 | 630 | 630 |
| Network switch (DE-I function) | | | | | | |
| Rated current | Ir | (A) | 630 | 630 | 630 | 630 |
| Breaking capacity | Active load | Iload | (A) | 630 | 630 | 630 |
| | Earth fault | Ief1 | (A) | 320 | 320 | 320 |
| | Cable charging | Icc | (A) | 110 | 110 | 110 |
| Making capacity of switch and earthing switches | Ima | (kA peak) | 62.5 | 52.5 | 40 | 50 |

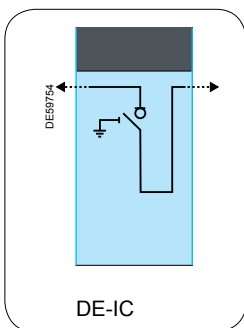

Accessories and options

Remote operation

Motorization including auxiliary contacts (LBSw 2 NO - 2 NC and ESw 1 O/C).

Auxiliary contacts alone

For switch position indication LBSw 2 NO - 2 NC and ESw 1 O/C (this option is included in remote operation option).

Front door of cable connection compartment

- Bolted
- Removable with ESw interlocking

- Removable with ESw interlocking and LBSw interlocking.

Key locking devices

- Type R1
- Type R2.

With or without earthing switch

Bus coupler by 630 A disconnecting circuit breaker (DE-BC function)

| | | | | | | |
|--|------------|--------------|------|--------|-----|--------|
| Rated voltage | Ur | (kV) | 12 | 17.5 | 24 | 24 |
| Short-time withstand current | Ik | (kA rms) | 25 | 17.5 | 16 | 20 |
| | tk | Duration (s) | 1 | 1 or 3 | 1 | 1 or 3 |
| Rated current busbars | Ir | (A) | 630 | 630 | 630 | 630 |
| Network disconnecting circuit breaker (DE-B function) | | | | | | |
| Rated current | Ir | (A) | 630 | 630 | 630 | 630 |
| Short-circuit breaking capacity | Isc | (kA) | 25 | 21 | 16 | 20 |
| Making capacity | Ima | (kA peak) | 62.5 | 52.5 | 40 | 50 |

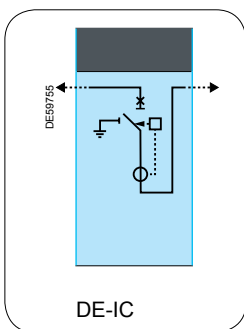

Accessories and options

Remote operation

Motorization including shunt trip coil and auxiliary contacts circuit breaker (CB 2 NO - 2 NC and ESw 1 O/C).

Auxiliary contacts alone

For circuit breaker position indication CB 2 NO - 2 NC and ESw 1 O/C (this option is included in remote operation option).

Front door of cable connection compartment

- Bolted
- Removable with ESw interlocking
- Removable with ESw interlocking and CB interlocking.

Shunt trip coil for external tripping

- 24 Vdc
- 48/60 Vdc
- 120 Vac

- 110/125 Vdc - 220 Vac
- 220 Vdc/380 Vac.

Undervoltage coil

- 24 Vdc
- 48 Vdc
- 125 Vdc
- 110-230 Vac.

Protection relay for CB transformer protection (VIP 400, 410 or Sepam series 10)

Forbidden closing under fault 1 NC

Auxiliary contact D or B tripping

Key locking devices

- Type R6
- Type R7
- Type R8.

With or without earthing switch

Detailed characteristics for each function

Cable connection cubicles LE-O, RE-O, DE-O

| | | | | | | | | | |
|--------------------------------------|-----------|--------------|-----|-----|------|------|-----|-----|--------|
| Rated voltage | Ur | (kV) | 12 | 12 | 17.5 | 17.5 | 24 | 24 | 24 |
| Rated current busbars | Ir | (A) | 630 | 630 | 630 | 630 | 630 | 630 | 630 |
| Cable connection (O function) | | | | | | | | | |
| Rated current | Ir | (A) | 200 | 630 | 200 | 630 | 200 | 630 | 630 |
| Short-time withstand current | Ik | (kA rms) | 25 | 25 | 21 | 21 | 16 | 16 | 20 |
| | tk | Duration (s) | 1 | 1 | 3 | 3 | 1 | 1 | 1 or 3 |
| Bushing | | | C | C | C | C | C | C | C |

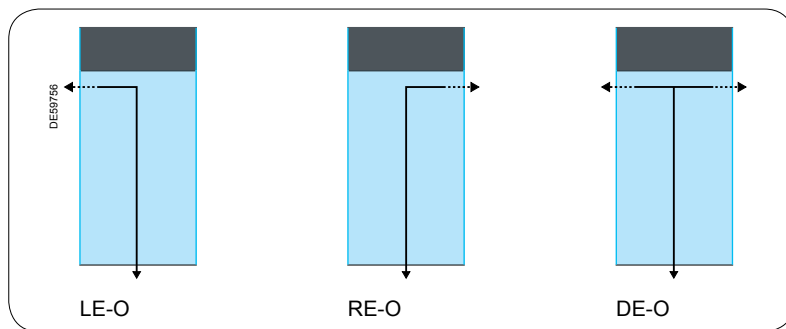

Metering module DE-Mt

| | | | | | | |
|---------------------------------------|-----------|--------------|-----------|-----------|-----------|-----------|
| Rated voltage | Ur | (kV) | 12 | 17.5 | 24 | 24 |
| Rated current busbars | Ir | (A) | 630 | 630 | 630 | 630 |
| MV metering (DE-Mt function) | | | | | | |
| Rated current | Ir | (A) | 630 | 630 | 630 | 630 |
| Short-time withstand current | Ik | (kA rms) | 25 | 21 | 16 | 20 |
| | tk | Duration (s) | 1 | 1 or 3 | 1 | 1 or 3 |
| Cubicle internal arc withstand | | | 16 kA 1 s | 16 kA 1 s | 16 kA 1 s | 16 kA 1 s |

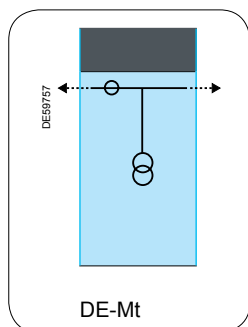

Voltage transformers configuration

Schneider Electric models or DIN 42600 type section 9.
2 phase-phase VT, 2 phase-earth VT, 3 TT phase-earth VT.

Fitted right or left of the CT's.
Optional fuse protection.

Current transformers configuration

Schneider Electric models or DIN 42600 type section 8.
2 CT or 3 CT.

Accessories and options

- Additional low voltage unit
- Door key locking devices
- Type R7 tubular.

Medium Voltage metering

The RM6 is boosted by the DE-Mt module

This air-insulated cubicle is fitted with conventional current transformers and voltage transformers enabling invoicing of MV power. It has an internal arc withstand and is integrated in the RM6 unit by a direct connection to the adjacent busbars.



Increased environmental insensitivity

- By eliminating risks related to MV cables (incorrect connection, non-compliance with radius of curvature between two adjacent cubicles, etc...).
- Completely closed module (no opening to the bottom, no ventilation grid).
- Factory tested module.

A clear separation between MV and LV

Everything is done to avoid having to act on the MV compartment. The secondary of CT and VT's are cabled to the customer terminal in an LV compartment.

This LV compartment enables:

- connection to a remote power meter (in another room)
- or connection to the LV unit mounted on the LV compartment (option).

An LV unit adapted to your requirements

This unit allows the installation of active power meters, a reactive power meter, and all auxiliaries for monitoring current, voltage and consumed power.

Metering harsh environment

Current and voltage transformers for metering tough environment.

Produce auxiliary voltage :

- Adding metallic VT in some RM6 cubicles (I function).

The VRT4 is a phase-to-earth screened voltage transformer, placed behind the cables. Totally insensitive to harsh atmosphere effects, it does not require any fuse protection. A flexible connection to the front T-type cable plugs can be easily disconnected for commissioning tests.



VRT4

| Standard | IEC 60044-2 | | | | | | | | |
|---------------------------------|---------------|---------------|--------------|--------------|----------------|--------|---------|--------|--|
| Voltage (kV) | 7.2 - 20 - 60 | 7.2 - 32 - 60 | 12 - 28 - 75 | 12 - 42 - 75 | 17.5 - 38 - 95 | | | | |
| Primary (kV) | 6/√3 | 6.6/√3 | 6/√3 | 10/√3 | 11/√3 | 10/√3 | 13.8/√3 | 15/√3 | |
| 1 st secondary (V) | 100/√3 | 110/√3 | 100/√3 | 100/√3 | 110/√3 | 100/√3 | 110/√3 | 100/√3 | |
| Rated output and accuracy class | 10 VA cl 0.2 | | | | | | | | |
| 2 nd secondary (V) | 100/3 | 110/3 | 100/3 | 100/3 | 110/3 | 100/3 | 110/3 | 100/3 | |
| Rated output and accuracy class | 30 VA 3P | | | | | | | | |

The ARC5 is a ring-type current transformer used in core unit.

- Compact dimensions for easy installation.
- Cost-effective compared to standard MV block CTs.



ARC5

| | | | | |
|--|-------------|-------|-------|-------|
| Rated & Insulation voltage (kV) | 0.72/3 | | | |
| Thermal withstand | 25 kA x 2 s | | | |
| Transformation ratio | 100/5 | 200/5 | 400/5 | 600/5 |
| Rated output with class 0,2S Fs ≤ 5 (VA) | 5 | | | |

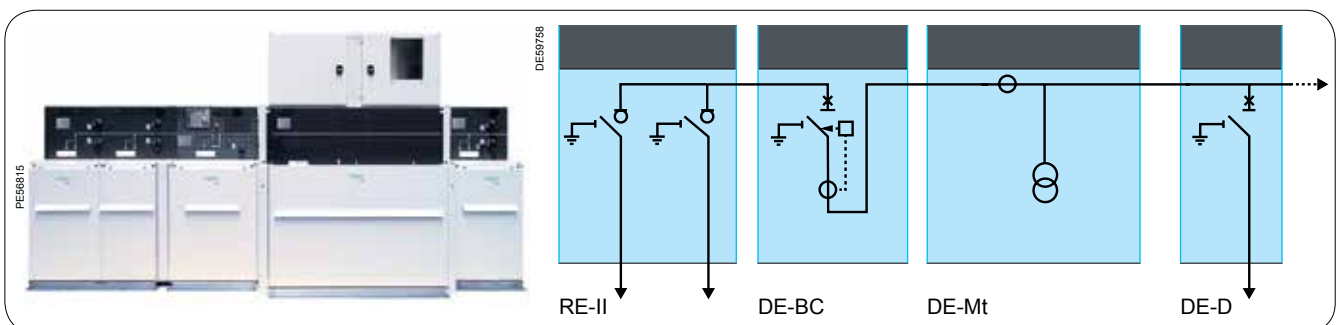

RM6 Free Combination - Configuration

RM6 Free Combination is a new range extension and allows a higher configuration flexibility of switchboards to meet all your needs:

- Free choice of functions and options
- Compatible with standard RM6 offer
- Tanks including from 2 to 3 free choice functions
- More economical compared to several single extension function in line.



Quick and simple site installation

- Compactness
- Innovative choice of arrangement inside the tank
- Reduced maintenance operations

700 possible combinations for RM6 2 or 3 functions

Possible combinations of RM6 2 functions

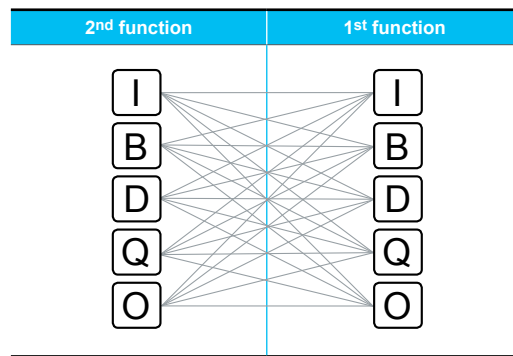

Type of tank:

- NE: non extensible
- RE: extensible to the right
- LE: extensible to the left
- DE: extensible to the right and left.

Possible combinations of RM6 3 functions

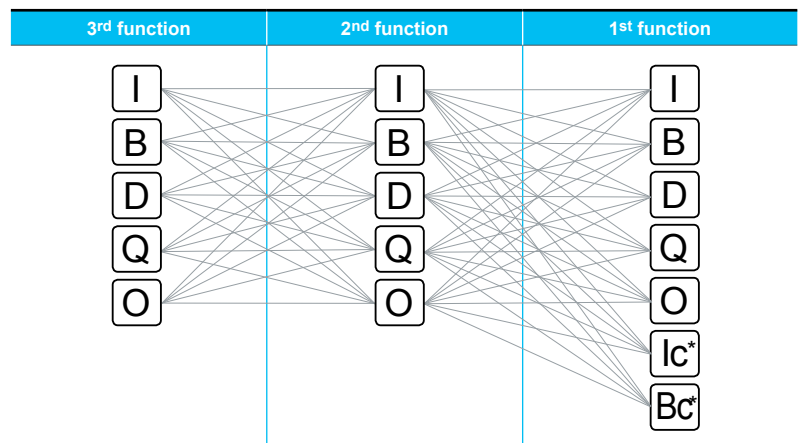

* Possible only when RM6 is RE or DE.

Examples

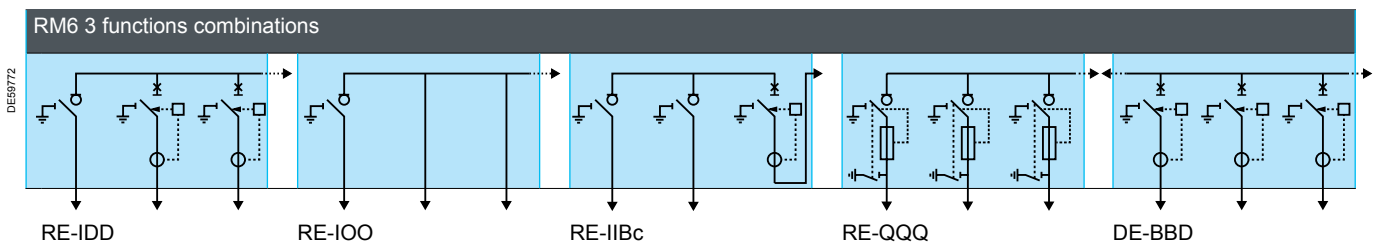
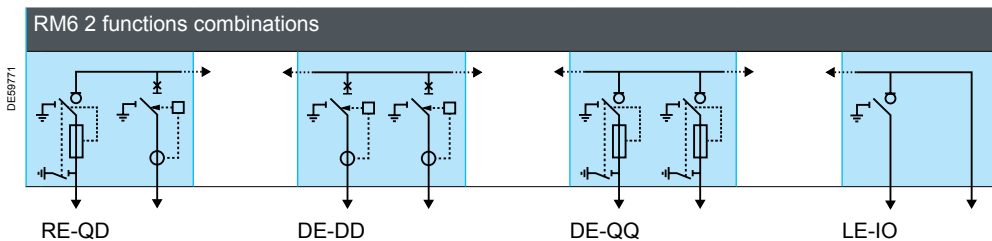

RM6 Free Combination - Applications

Examples of typical applications

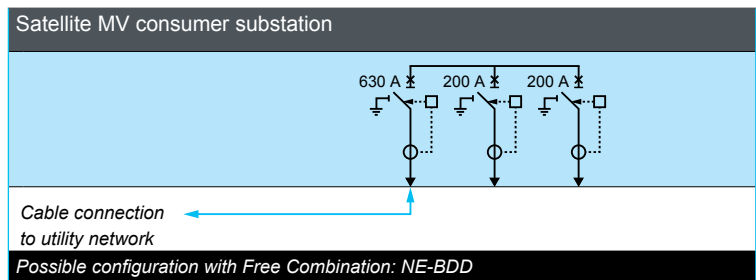
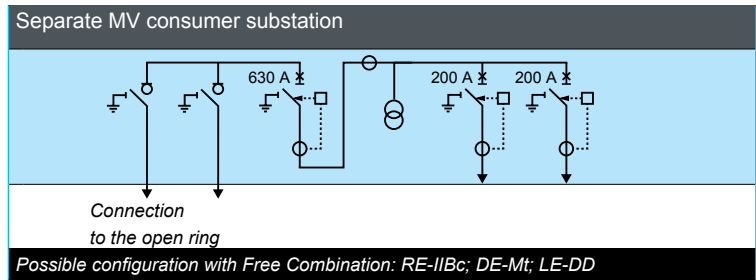
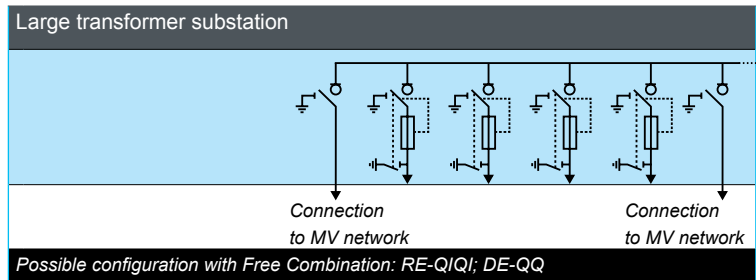
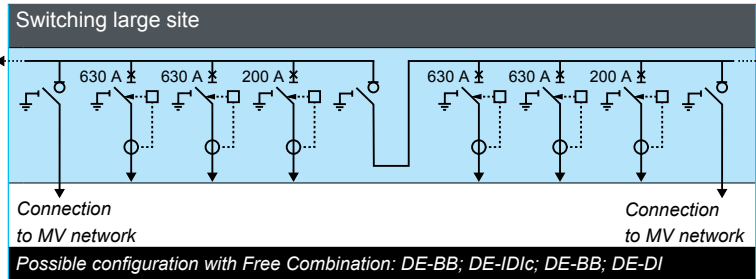
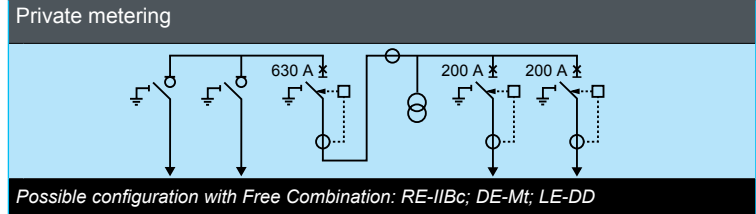

RM6 5 functions - Configuration

RM6 5 functions is an evolution and allows a higher configuration flexibility of switchboards to meet all your needs:

- 5 functions: 3 fixed and 2 free
- Compatible with standard RM6 offer
- Tanks including 5 functions
- More economical compared to several single extension function in line.



Quick site installation

- Compactness
- Reduced maintenance operations

Possible combinations of RM6 5 functions

Type of tank:

- NE: non extensible
- RE: extensible to the right
- LE: extensible to the left
- DE: extensible to the right and left.

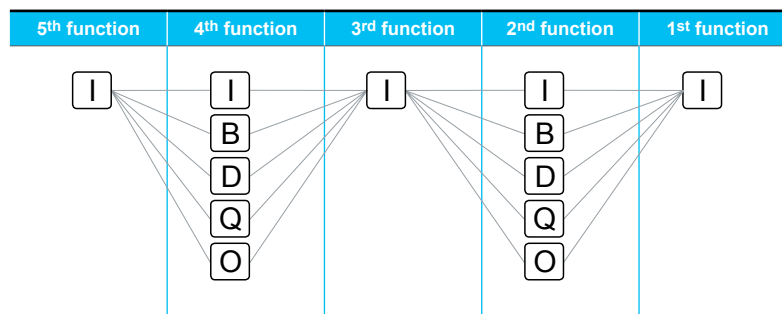

Examples

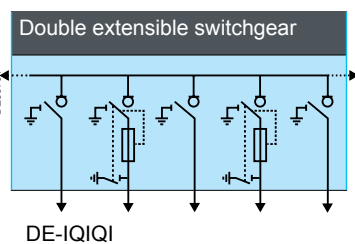
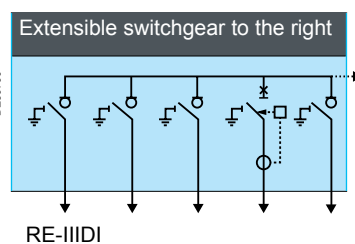
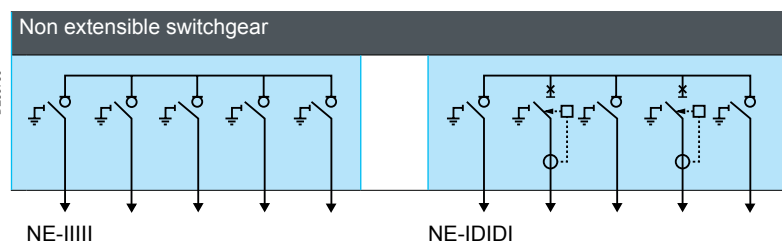

Circuit breaker function Protection relays selection

VIP 40, 45, 400, 410 & Sepam series 10 selection guide relays

| | | VIP series | | | | Sepam series | |
|--|---|--|--------|--------------------|-----------|-----------------|-----------|
| | | Integrated self-powered protection optimised for RM6 | | | | General | |
| | | Transformer protection | | General protection | | Sepam series 10 | |
| | | VIP 40 | VIP 45 | VIP 400 | VIP 410 | B | A |
| ANSI code | | | | | | | |
| Protection functions | | | | | | | |
| Phase overcurrent | | 50-51 | ■ | ■ | ■ | ■ | ■ |
| Earth fault phase | Standard (sum of current method) | 51N | | ■ | ■ | ■ | □ |
| | High sensitivity (earth fault CTs) | | | | ■ | □ | □ |
| Thermal overload | | 49 | | ■ | ■ | ■ | ■ |
| Logic discrimination | Blocking send | 68 | | | | ■ | ■ |
| | Blocking reception | | | | | | ■ |
| Cold load pick-up | | | | | ■ | ■ | ■ |
| Other protection functions (1) | | | | | | ■ | ■ |
| Measurement functions | | | | | | | |
| Phase current | | | ■ | ■ | ■ | ■ | ■ |
| Earth current | | | | ■ | ■ | ■ | ■ |
| Phase peak demand current | | | ■ | ■ | ■ | ■ | ■ |
| Load histogram | | | | | ■ | | |
| Control and monitoring functions | | | | | | | |
| CB tripping | | | Mitop | Mitop | Mitop | Mitop | Coil |
| Trip circuit supervision | | 74TC | ■ | ■ | ■ | ■ | ■ |
| Time-tagged events | Local on display (5 last trips) | | | | ■ | ■ | ■ |
| | Remote, via communication | | | | | | ■ |
| External tripping input | | | | | ■ | ■ | ■ |
| Cumulative breaking current, number of trip orders | | | | | ■ | | |
| Overcurrent and breaking profile | Number of phase and earth trips (2) | | | ■ | ■ | ■ | ■ |
| Serial communication port | Modbus RS485 | | | | ■ | ■ | ■ |
| Logic relay inputs (except TCS) used for: | | | | | 1 | 0 or 2 | 0 or 2 |
| | External tripping | | | | 1 | 1 | 1 |
| | Local / Remote | | | | | 1 | 1 |
| Logic relay ioutputs used for: | | | | | 3 | 3 or 7 | 3 or 7 |
| | Circuit breaker closing by remote control | | | | | 1 | 1 |
| | Logic discrimination (Blocking send) | | | | | 1 | 1 |
| | Watchdog | | | | By modbus | 1 | 1 |
| | Customised output via setting | | | | | 3 | 4 |
| Power supply | | | | | | | |
| Type of supply | Self-powered or auxiliary | | Self | Self | Self | DUAL Power (1) | Auxiliary |
| | Minimum 3 phase load currents to activate the VIP | | 4 A | 4 A | 7 A (3) | | |

(1) The protection is self-powered. Auxiliary power is used only for communication and high sensitive earth fault protection.

(2) The number of trips is displayed in 4 levels:

For D01 and D02: < 200 A, < 2 kA, < 8 kA, > 8 kA

For D06 and D06H: < 630 A, < 10 kA, < 20 kA, > 20 kA.

(3) 14 A with 630 A CBs

■ Function available

□ Function availability depends on the Sepam model.

Transformer protection by circuit breaker VIP 40, VIP 45

Schneider Electric recommends circuit breakers for transformer protection instead of fuses.

They offer the following advantages:

- Easy to set
- Better discrimination with other MV and LV protection devices
- Improved protection performance for inrush currents, overloads, low magnitude phase faults and earth faults
- Greater harsh climate withstand
- Reduced maintenance and spare parts
- Availability of additional functions such as measurement, diagnostics and remote monitoring
- And with the recent development of low cost circuit breakers and self-powered relays, life time costs are now equivalent to those of traditional MV switch fuse solutions.

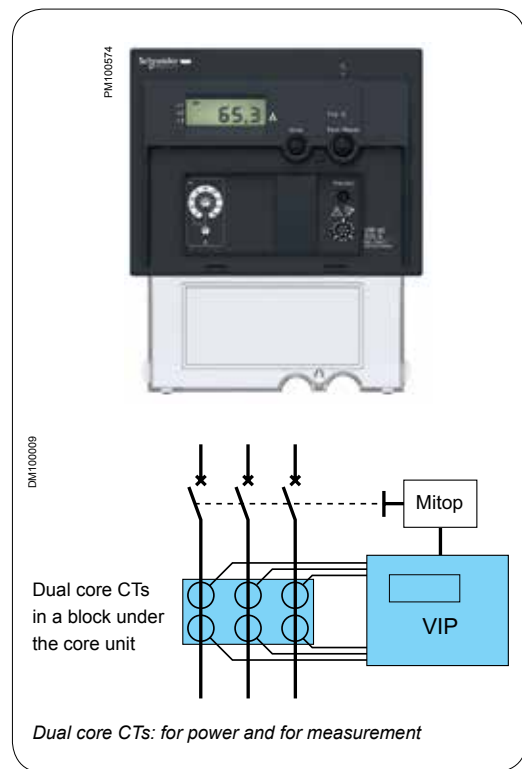

Applications

- Entry level MV/LV transformer protection
- Dependent-time phase overcurrent tripping curve dedicated to MV/LV transformer protection
- Definite-time earth fault protection
- Phase current and peak demand current measurement.

Main features

Self-powered operation

- Energised by the CTs: no auxiliary power needed.

Complete pre-tested protection system

- Functional block ready to be integrated.

Phase overcurrent protection

- Tripping curve optimised for MV/LV transformer protection
- Protection against overloads and secondary and primary short-circuits
- Second harmonic restraint filtering
- Only one setting ($I >$)
- Discrimination with LV circuit breakers or LV fuses
- Compliant with TFL (Time Fuse Link) operating criteria.

Earth fault protection

- Definite-time tripping curve
- Settings: $Io >$ (phase current sum method) and $to >$
- Second harmonic restraint element.

Measurement

- Load current on each phase
- Peak demand current.

Front panel and settings

- Current measurements displayed on a 3 digit LCD
- Settings with 3 dials ($I >$, $Io >$, $to >$) protected by a lead-sealable cover
- Trip indication powered by dedicated integrated battery with reset by pushbutton or automatically.

Other features

- Complete pre-tested solution that eliminates complicated CT selection
- Complies with MV protection relay standard IEC 60255
- No PC or specific tool required for setting or commissioning
- Maximum setting possibilities consistent with circuit breaker features
- Self-powered by dual core CTs: Cuar
- Environment: $-40^{\circ}\text{C} / +70^{\circ}\text{C}$.

Test with the Pocket Battery module

- This accessory can be connected on the VIP 40 and VIP 45 front plate to energise the relay to carry out a quick test even when the relay is not powered (the temporary "VIP 40/45 test mode" can be activated for the circuit breaker).

Rated protection current setting selection by VIP 40 and VIP 45

| Operating voltage (kV) | Transformer rating (kVA) | | | | | | | | | | | | | | | | | | | | | |
|------------------------|--------------------------|----|-----|-----|-----|-----|-----|-----|-----|-----|-----|-----|------|------|------|------|------|------|------|------|------|--|
| | 50 | 75 | 100 | 125 | 160 | 200 | 250 | 315 | 400 | 500 | 630 | 800 | 1000 | 1250 | 1600 | 2000 | 2500 | 3150 | 4000 | 5000 | 6300 | |
| 3 | 10 | 15 | 20 | 25 | 36 | 45 | 55 | 68 | 80 | 115 | 140 | 170 | 200 | | | | | | | | | |
| 3.3 | 10 | 15 | 18 | 22 | 28 | 36 | 45 | 56 | 70 | 90 | 115 | 140 | 200 | | | | | | | | | |
| 4.2 | 8 | 12 | 15 | 18 | 22 | 28 | 36 | 45 | 55 | 70 | 90 | 115 | 140 | 200 | | | | | | | | |
| 5.5 | 6 | 8 | 12 | 15 | 18 | 22 | 28 | 36 | 45 | 55 | 68 | 90 | 115 | 140 | 170 | | | | | | | |
| 6 | 5 | 8 | 10 | 12 | 18 | 20 | 25 | 36 | 45 | 55 | 68 | 80 | 115 | 140 | 170 | 200 | | | | | | |
| 6.6 | 5 | 8 | 10 | 12 | 15 | 18 | 22 | 28 | 36 | 45 | 56 | 70 | 90 | 115 | 140 | 200 | | | | | | |
| 10 | 5* | 5 | 8 | 8 | 10 | 12 | 15 | 20 | 25 | 30 | 37 | 55 | 68 | 80 | 115 | 140 | 170 | 200 | | | | |
| 11 | 5* | 5* | 6 | 8 | 10 | 12 | 15 | 18 | 22 | 28 | 36 | 45 | 55 | 68 | 90 | 115 | 140 | 170 | | | | |
| 13.8 | 5* | 5* | 5 | 6 | 8 | 10 | 12 | 15 | 18 | 22 | 28 | 36 | 45 | 55 | 68 | 90 | 115 | 140 | 170 | | | |
| 15 | 5* | 5* | 5 | 6 | 8 | 8 | 10 | 15 | 18 | 20 | 25 | 36 | 45 | 55 | 68 | 80 | 115 | 140 | 170 | 200 | | |
| 20 | 5* | 5* | 5* | 5* | 6 | 6 | 8 | 10 | 12 | 15 | 20 | 25 | 30 | 37 | 55 | 68 | 80 | 115 | 140 | 170 | 200 | |
| 22 | 5* | 5* | 5* | 5* | 5 | 6 | 8 | 10 | 12 | 15 | 18 | 22 | 28 | 36 | 45 | 55 | 68 | 90 | 115 | 140 | 170 | |

* Short-circuit protection, no over-load protection

General protection by circuit breaker VIP 400 & VIP410

VIP 400 is a self-powered relay energised by the CTs; it does not require an auxiliary power supply to operate.

VIP 410 is a dual powered relay offering self-powered functions and additional functions powered by an AC or DC auxiliary supply.

Applications

- MV distribution substation incomer or feeder protection relay
- MV/LV transformer protection.

Main features

VIP 400: Self-powered protection relay

This version is energised by the current transformers (CTs). It does not require an auxiliary power supply to operate.

- Overcurrent and earth fault protection
- Thermal overload protection
- Current measurement functions.

Other features

- Designed for RM6 circuit breakers
- Complete pre-tested solution that eliminates complicated CT selection
- Complies with MV protection relay standard IEC 60255
- No PC or specific tool required for setting or commissioning
- Self-powered by dual core CTs
- Environment: -40°C / +70°C.

Test with the Pocket Battery module

- This accessory can be connected on the VIP relay front plate to energise the relay to carry out a quick test even though the relay is not powered. This module also makes it possible to test the circuit breaker.

VIP 410: Dual powered protection relay

- Offers the same self-powered functions as the VIP 400
- In addition, the VIP 410 has an AC or DC auxiliary supply to power certain additional functions that cannot be self-powered:

- sensitive earth fault protection
- external tripping input
- cold load pick-up
- communication (Modbus RS485 port)
- signaling.

- If the auxiliary power falls during an MV short-circuit, the protection functions are maintained.

Ready for smart grids

Dual supply for communication with

- DMS and RTUS
- Remote alarming
- Time stamped events
- Measurements of current, load history, overcurrent and breaking profile.

Dedicated to intelligent MV loops with automation

- Remote configuration
- Setting groups selectable according to the configuration of the MV loop
- Remote asset management
- Plug and play system with Easergy RTUs (R200) to integrate all protocols IEC 60870-104, DNP3, IEC 61850) and remote web pages.

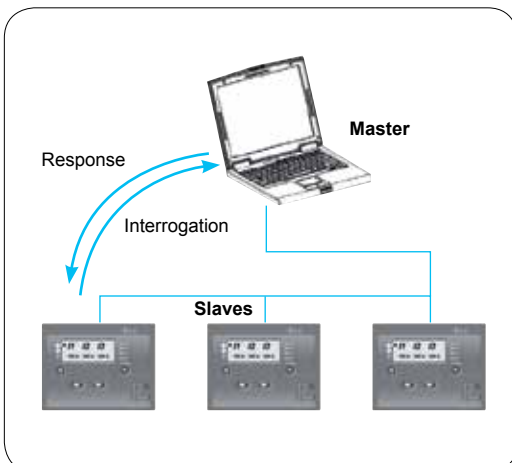
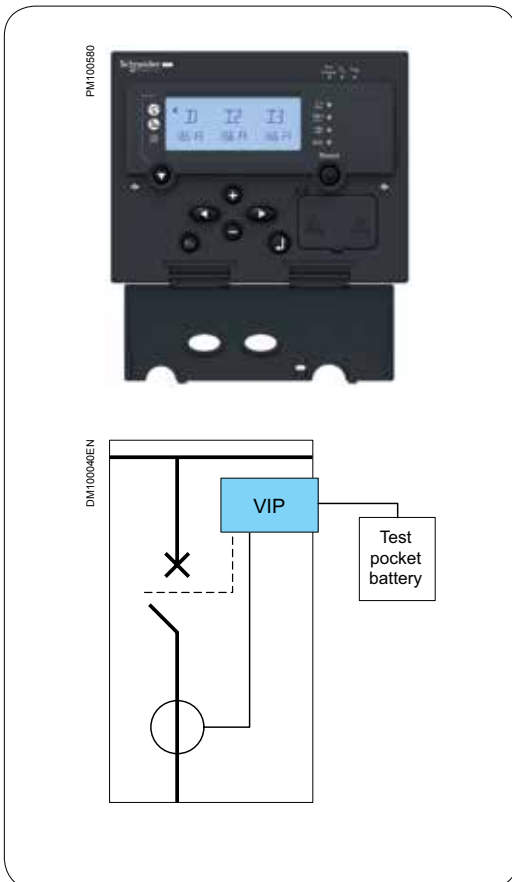

Transformer protection by circuit breaker VIP integrated system

The VIP series is an integrated protection system:

- Dedicated sensors located under the core unit provide protection and measurement outputs
- Optional additional earth fault sensors are available
- Actuators are low power tripping coils (Mitop).

High sensitivity sensors

VIP integrated protection system

The VIP integrated protection system is composed of sensors, a processing unit and an actuator, designed together to provide the highest level of reliability and sensitivity from 0.2 A to 20 In for VIP 400, VIP 410 and 5 A to 20 In for VIP 40 and VIP 45.

Sensors

The sensors are made up of one block of three CTs with rated and insulation voltages of 0.72 kV / 3 kV - 1 min, providing both measurement and power outputs.

- The measurement sensor is based on Low Power Current Transformer (LPCT) technology as defined by standard IEC 60044-8, ensuring excellent accuracy:
 - 5P30 for protection
 - class 1 for measurement.
- The power supply winding ensures calibrated self-powering of the relay even for currents of just a few Amperes
 - e.g. 7 A is sufficient for operation of the VIP 400 with a 200 A circuit breaker, up to its saturation level
 - e.g. 4 A is for operation of the VIP 40 up to its saturation level.

■ Optionally, the VIP 410 can be associated with an earth fault current transformer (a single zero-sequence CT) dedicated to sensitive earth fault protection with a low threshold down to 0.2A.

Actuators

- The actuator is a dedicated low power tripping coil (Mitop) specifically designed to operate with the sensors and the processing unit with minimum energy.
- The integrity of the Mitop circuit is continuously supervised (Trip Circuit Supervision function).

Connection diagrams

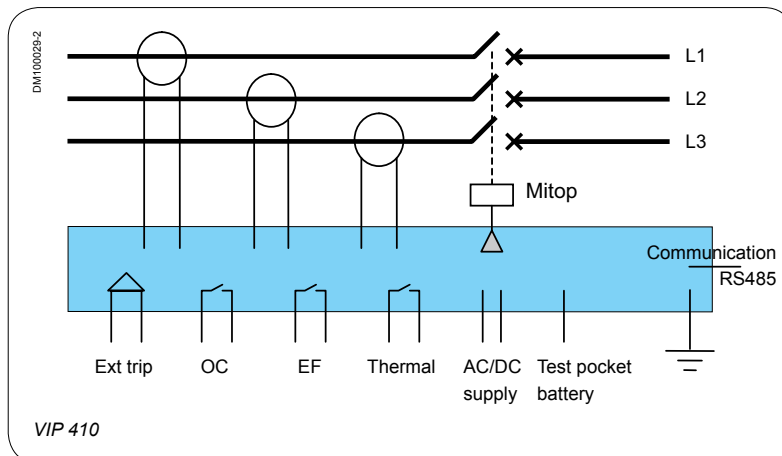
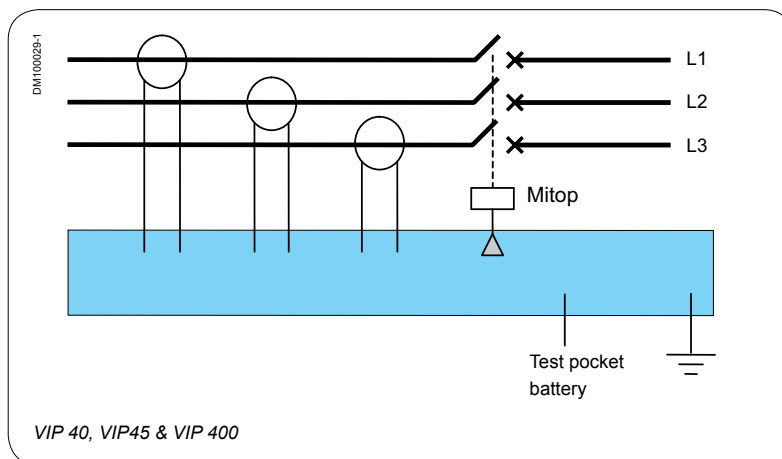

Line and transformer protection by circuit breaker Sepam series 10

Sepam series 10 protection relays

- Protection against phase to phase faults and earth faults, capable to detect the earth faults from 0.2 A.
- Possibility of communication with Easergy T200 I and remote circuit breaker control.
- Thermal image overload protection (ANSI 49RMS).
- Logic discrimination for shorter tripping time.
- Record of last fault or last five events.

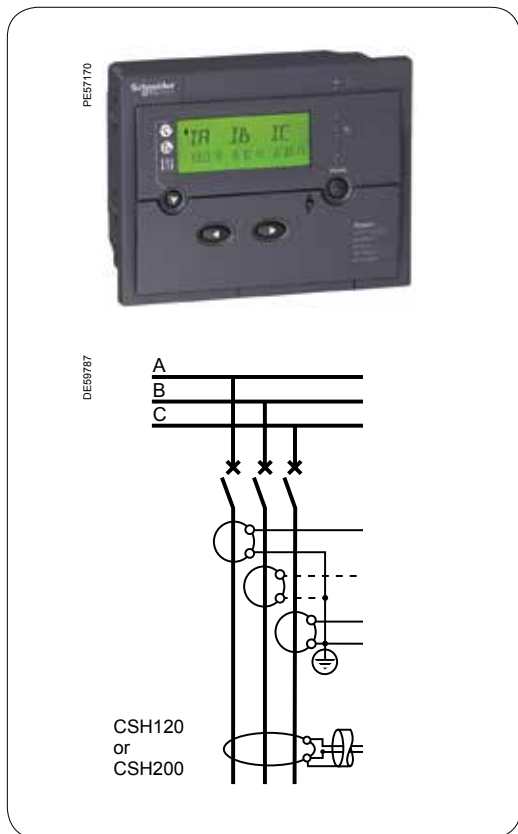

Main features

Protection system

The protection system includes:

- 3 current transformers mounted on the bushings (same as VIP)
- 1 specially designed homopolar transformer CSH120 or CSH200 for the measurement of residual current (only for high sensitivity models)
- 1 Sepam series 10 relay
- 1 trip coil of RM6.

The Sepam series 10 needs an auxiliary power supply (not included in RM6).

The Sepam series 10 of 24 or 48 Vdc can be supplied by T200 I with option dc/dc converter.

Simplicity and User-friendliness

- Easy operation: User-Machine Interface with screen, keys and pictograms. Parameter setting directly on the relay without need of computer.
- Operating languages: English, Spanish, French, Italian, German, Turkish and Portuguese.

Characteristics

- 4 logic inputs
- 7 relay outputs
- 1 communication port.

| Functions | ANSI code | Sepam series 10 | | |
|--|--------------------|-----------------|--------------------------|--------------------------|
| | | B | A | |
| Protections | | | | |
| Earth-fault protection | Standard | 50N/51N | <input type="checkbox"/> | <input type="checkbox"/> |
| | High sensitivity | | <input type="checkbox"/> | <input type="checkbox"/> |
| Phase-overcurrent protection | | 50/51 | ■ | ■ |
| Thermal overload protection | | 49RMS | ■ | ■ |
| Phase-overcurrent and earth fault protection cold load pick-up | | | ■ | ■ |
| Logic discrimination | Blocking send | 68 | ■ | ■ |
| | Blocking reception | | | ■ |
| External tripping | | | | ■ |
| Measurements | | | | |
| Earth-fault current | | | ■ | ■ |
| Phase currents | | | ■ | ■ |
| Peak demand currents | | | ■ | ■ |
| Control and supervision | | | | |
| Circuit breaker tripping and lockout | | 86 | ■ | ■ |
| Tripping indication | | | ■ | ■ |
| Trip-circuit supervision | | | | ■ |
| Remote circuit-breaker control | | | | ■ |
| Record of last fault | | | ■ | |
| Record of last five events | | | | ■ |
| Communication | | | | |
| Modbus | | | | ■ |
| IEC 60870-5-103 | | | | ■ |
| Inputs / Outputs (Number) | | | | |
| Earth-fault current inputs | | | 1 | 1 |
| Phase-current inputs | | | 2 or 3 | 3 |
| Logic relay outputs | | | 3 | 7 |
| Logic inputs | | | - | 4 |
| RS 485 communication port | | | - | 1 |

■ Function available.

□ Function availability depends on the Sepam model.

PE5770



Line and transformer protection by circuit breaker Core balance CTs CSH120, CSH200

The specifically designed **CSH120** and **CSH200** core balance CTs are used for direct residual current measurement. The only difference between them is the diameter. Due to their low voltage insulation, they may be used only on cables with earthed shielding.



Characteristics

| | CSH120 | CSH200 |
|-----------------------------|--|------------------|
| Inner diameter | 120 mm (4.7 in) | 200 mm (7.9 in) |
| Weight | 0.6 kg (1.32 lb) | 1.4 kg (3.09 lb) |
| Accuracy | ±5% to 20 °C (68 °F) | |
| | ±6 % max. from -25°C to 70°C (-13°F to +158°F) | |
| Transformation ratio | 1/470 | |
| Maximum permissible current | 20 kA - 1 s | |
| Operating temperature | -25°C to +70°C (-13°F to +158°F) | |
| Storage temperature | -40°C to +85°C (-40°F to +185°F) | |

Dimensions

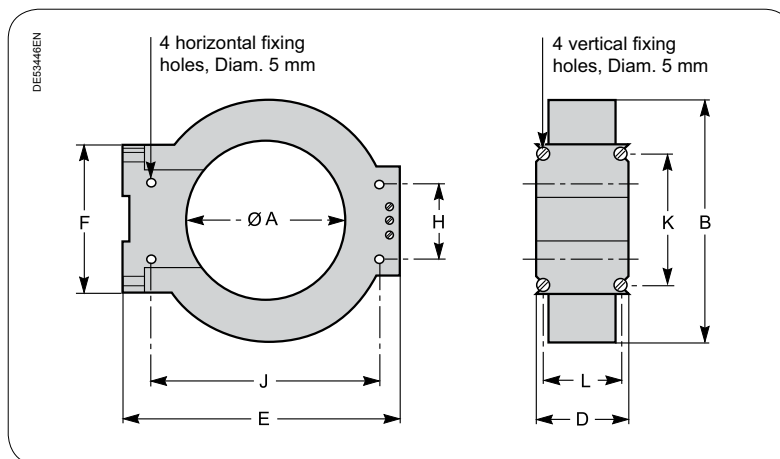

| Dimensions | | A | B | D | E | F | H | J | K | L |
|---------------|----|------|------|------|------|------|------|------|------|------|
| CSH120 | mm | 120 | 164 | 44 | 190 | 76 | 40 | 166 | 62 | 35 |
| | in | 4.72 | 6.46 | 1.73 | 7.48 | 2.99 | 1.57 | 6.54 | 2.44 | 1.38 |
| CSH200 | mm | 200 | 256 | 46 | 274 | 120 | 60 | 257 | 104 | 37 |
| | in | 7.87 | 10.1 | 1.81 | 10.8 | 4.72 | 2.36 | 10.1 | 4.09 | 1.46 |

Transformer protection by fuse-switches



Fuse replacement

IEC recommendations stipulate that when a fuse has blown, **all three fuses must be replaced.**

Characteristics

Ratings for fuses for transformer protection depend, among other points, on the following criteria:

- service voltage
- transformer rating
- thermal dissipation of the fuses
- fuse technology (manufacturer).

Type of fuse may be installed:

- **Fusarc CF type:** according to IEC 60282-1 dimensional standard, with or without striker.

Example (using the selection table below) general case, for protection of a 400 kVA transformer at 10 kV, **Fusarc CF** fuses with a rating of 50 A are chosen.

Correct operation of the RM6 is not guaranteed when using fuses from other manufacturers.

Selection table

(Rating in A, no overload, $-25^{\circ}\text{C} < \theta < 40^{\circ}\text{C}$)

Fuse type Fusarc CF and SIBA (1) (General case, IEC 60282-1 standard, IEC 62271-105 (to replace IEC 60420) and DIN 43625 standard)

| Operating voltage (kV) | Transformer rating (kVA) | | | | | | | | | | | | | | | | Rated voltage (kV) |
|------------------------|--------------------------|------|-----|-----|------|-----|------|------|---------|-------------|-------------|-------------|-------------|-------------|---------|---------|--------------------|
| | 50 | 75 | 100 | 125 | 160 | 200 | 250 | 315 | 400 | 500 | 630 | 800 | 1000 | 1250 | 1600 | 2000 | |
| 3 | 20 | 31.5 | 40 | 50 | 50 | 63 | 80 | 100 | 125 (2) | 160 (1) (2) | | | | | | | 12 |
| 3.3 | 20 | 25 | 40 | 40 | 40 | 63 | 80 | 80 | 125 (2) | 125 (2) | 160 (1) (2) | | | | | | |
| 4.2 | 20 | 25 | 25 | 40 | 50 | 50 | 63.5 | 80 | 80 | 100 | 125 (2) | 160 (1) (2) | | | | | |
| 5.5 | 16 | 20 | 25 | 25 | 40 | 40 | 50 | 63 | 80 | 80 | 100 | 125 (2) | 160 (1) (2) | | | | |
| 6 | 16 | 20 | 25 | 25 | 31.5 | 40 | 50 | 50 | 63 | 80 | 100 | 125 (2) | 160 (1) (2) | | | | |
| 6.6 | 10 | 20 | 25 | 25 | 31.5 | 40 | 50 | 50 | 63 | 63 | 80 | 100 | 125 (2) | 160 (1) (2) | | | |
| 10 | 10 | 10 | 16 | 20 | 25 | 25 | 31.5 | 40 | 50 | 50 | 63 | 80 | 100 | 125 (2) | | | |
| 11 | 10 | 10 | 16 | 20 | 20 | 25 | 25 | 40 | 40 | 50 | 50 | 63 | 80 | 100 | 125 (2) | | |
| 13.8 | 10 | 10 | 10 | 16 | 16 | 20 | 25 | 31.5 | 40 | 40 | 50 | 50 | 63 | 100 (2) | | | 24 |
| 15 | 10 | 10 | 10 | 10 | 16 | 20 | 25 | 31.5 | 31.5 | 40 | 50 | 50 | 63 | 80 | 100 (2) | | |
| 20 | 10 | 10 | 10 | 10 | 16 | 16 | 20 | 25 | 25 | 31.5 | 40 | 40 | 63 | 63 | 80 | 100 (2) | |
| 22 | 10 | 10 | 10 | 10 | 10 | 16 | 16 | 20 | 25 | 31.5 | 40 | 40 | 50 | 63 | 80 | 100 (2) | |

(1) SIBA type fuses at 160 A/12 kV reference 30-020-13.

(2) In the case of an external trip system (e.g.: overcurrent relay) A calculation must be carried out to guarantee coordination of fuse-switches – Please consult us. For any values not included in the table, please consult us. In the case of an overload beyond 40°C, please consult us.

Fuses dimensions

| Fusarc CF | | Ur (kV) | Ir (A) | L (mm) | Ø (mm) | Mass (kg) |
|-----------|--|---------|------------|--------|--------|-----------|
| | | 12 | 10 to 25 | 292 | 50.5 | 1.2 |
| | | | 31.5 to 40 | 292 | 55 | 1.8 |
| | | | 50 to 100 | 292 | 76 | 3.2 |
| | | | 125 | 442 | 86 | 5 |
| | | 24 | 10 to 25 | 442 | 50.5 | 1.7 |
| | | | 31.5 to 40 | 442 | 55 | 2.6 |
| | | | 50 to 80 | 442 | 76 | 4.5 |
| | | | 100 | 442 | 86 | 5.7 |



network

network

Schneider Electric offers you a complete solution, including remote control and monitoring interface and MV switchgear that is adapted for telecontrol.

Contents

| | |
|-----------------------------|-----|
| Architecture and SCADA L500 | D-2 |
| Easergy T200 I control unit | D-3 |
| Automatic transfer systems | D-4 |
| Motorization | D-8 |

Architecture and SCADA L500

Continuity of service guaranteed by an overall telecontrol offer

Schneider Electric offers you a complete solution, including:

- the Easergy T200 I telecontrol interface
- MV switchgear that is adapted for telecontrol.

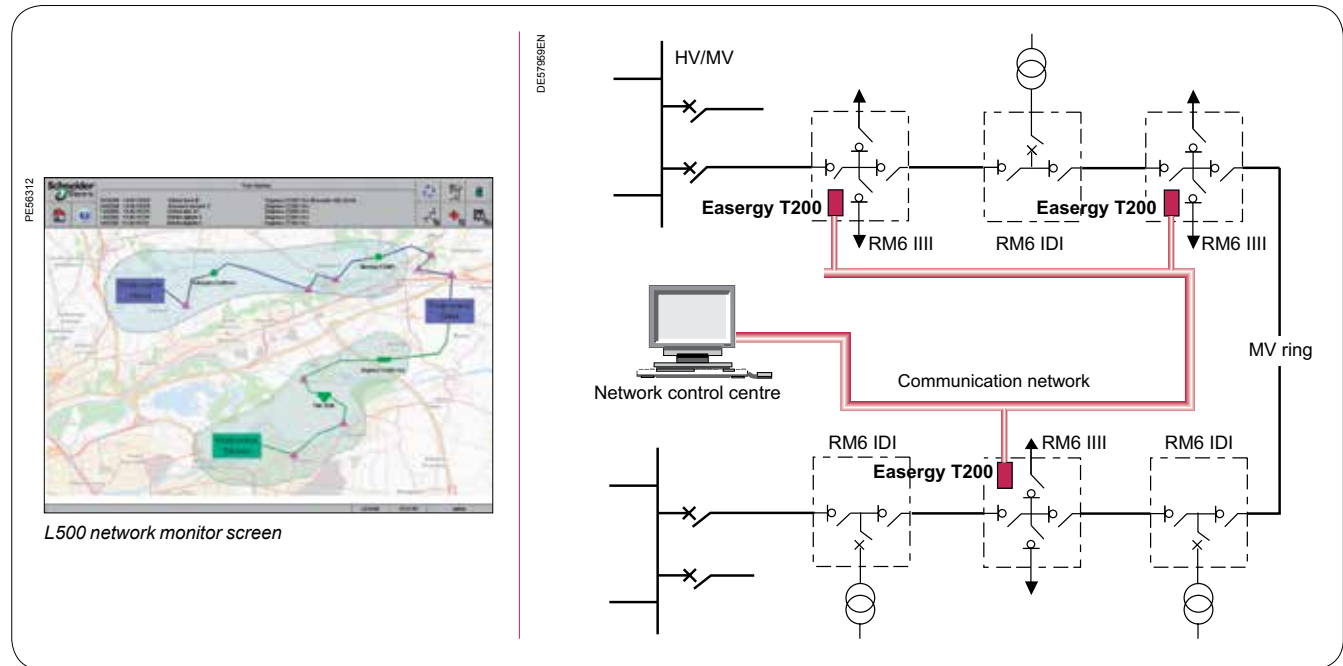

Easergy L500, a low cost solution to immediately improve your SAIDI (System Average Interruption Duration Index)

Easergy L500 is a SCADA providing all the functions needed to operate the MV network in real time

- Pre-configured with Easergy range products for monitoring and control of MV networks:
 - MV/LV substations equipped with T200 I or Flair 200C
 - Overhead LBS equipped with T200 P
 - Overhead line equipped with Flite 116/G200
 - Overhead CB equipped with ADV C ACR U and N series
- Broad range of transmission supports: Radio, GSM, GPRS, 3G, PSTN, LL, FO.

Advantages

- Simple implementation:
 - One to two weeks only for 20 MV/LV units
 - Configuration, training and handling within a few days
- Simple and fast evolutions by operations managers
- Short return on investment
- Service quality and operations rapidly improved.

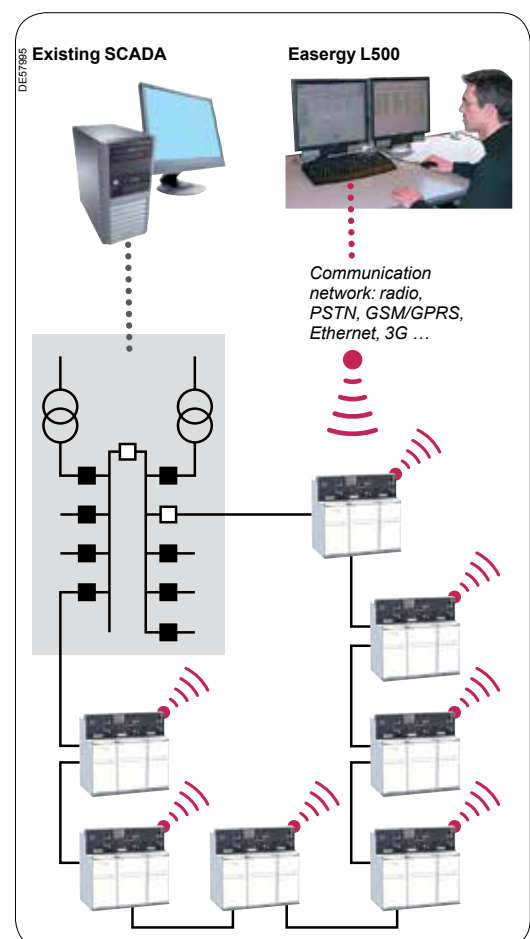

Easergy T200 I control unit

Easergy T200 I: an interface designed for telecontrol of MV networks

Easergy T200 I is a "plug and play" or multifunction interface that integrates all the functional units necessary for remote supervision and control of the RM6:

- acquisition of the different types of information: switch position, fault detectors, current values...
- transmission of switch open/close orders
- exchanges with the control center.

Required particularly during outages in the network, Easergy T200 I is of proven reliability and availability, being able to ensure switchgear operation at any moment.

It is simple to set up and to operate.

Functional unit designed for the Medium Voltage network

- Easergy T200 I is designed to be connected directly to the MV switchgear, without requiring a special converter.
- It has a simple front plate for local operation, which allows management of electrical rating mechanisms (local/remote switch) and display of information concerning switchgear status.
- It has an integrated MV network fault current detection system (overcurrent and zero sequence) with detection set points that can be configured channel by channel (current value and fault current duration).

Medium Voltage switchgear operating guarantee

- Easergy T200 I has undergone severe MV electrical stress withstand tests.
- It is a backed up power supply which guarantees continuity of service for several hours in case of loss of the auxiliary source, and supplies power to the Easergy T200 I and the MV switchgear motor mechanisms.
- **Ready to plug**
 - Easergy T200 I is delivered with a kit that makes it easy to connect the motor mechanisms and collect measurements.
 - The telecontrol cabinet connectors are polarized to avoid any errors during installation or maintenance interventions.
 - Current measurement acquisition sensors are of the split type (to facilitate their installation) or of closed type mounted on RM6 bushings.
 - Works with 24 Vdc and 48 Vdc motor units.

Please consult the Easergy T200 I documentation for any further information.



Local information and control



Monitoring and control



Back up power supply



Polarized connectors



Split sensors



CT on bushings

Automatic transfer systems

Because a MV power supply interruption is unacceptable especially in critical applications, an automatic system is required for MV source transfer.

For your peace of mind, RM6 gives automatic control and management of power sources in your Medium Voltage secondary distribution network with a short transfer time (less than 10 seconds), guaranteeing the hi-reliability of your installation.

Automatic control is performed by Easergy T200 I. This T200 I device can also be used for remote control with a wide range of modems and protocols. By default, the T200 I is provided with the RS232 modem and the Modbus/IP protocol.



An ATS solution is made of:

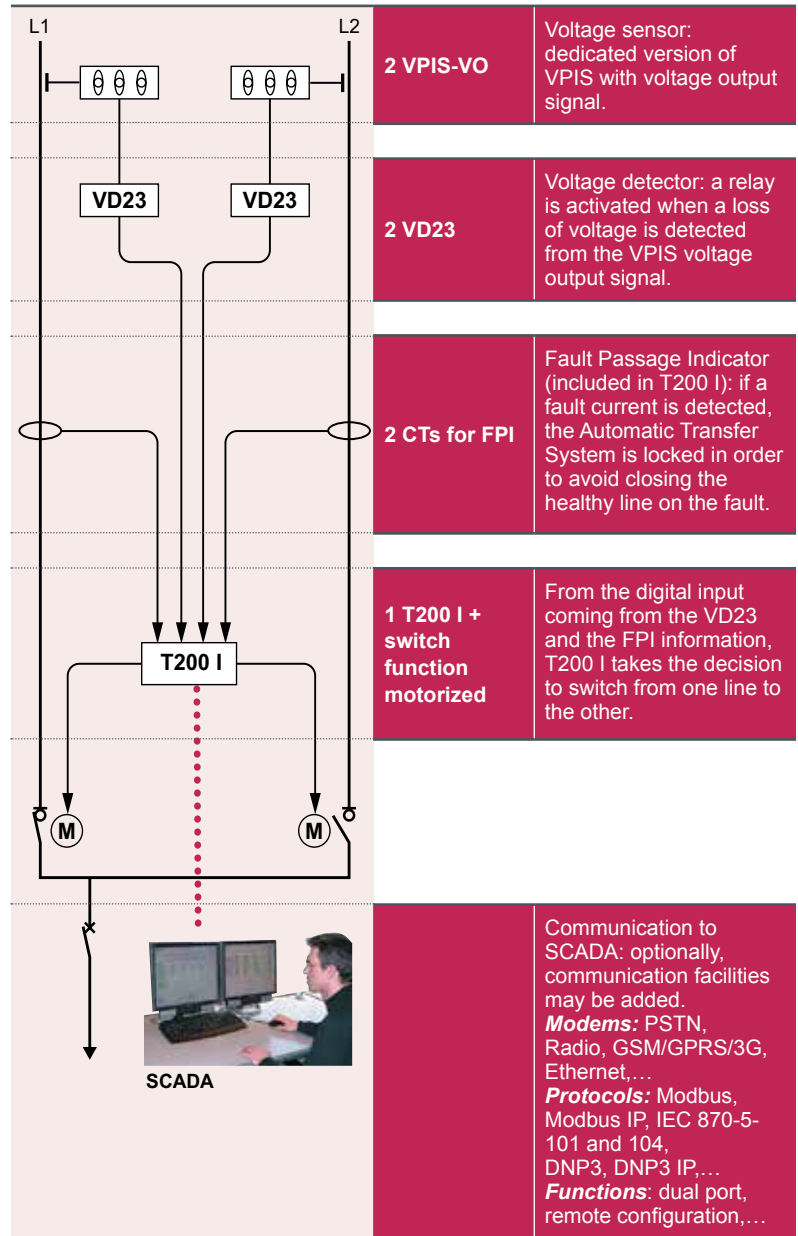

Automatic transfer systems

Network ATS (1/2): changeover between two MV network sources.

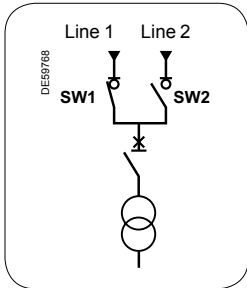

3 operating modes (selected from the T200 I Web server)

1 - Auto SW1 or Auto SW2 mode

In the event of a voltage loss on the distribution line in service (SW1), the ATS changes over to the backup line (SW2) after a configurable time delay (T1).
[opening of SW1, closing of SW2]

As soon as voltage returns on the main line (SW1), the ATS changes back to the main line after a time delay (T2).

[opening of SW2, closing of SW1 if the paralleling option is not activated]
[closing of SW1, opening of SW2 if the paralleling option is activated]

2 - Semi-Auto SW1 ↔ SW2

In the event of a voltage loss on the distribution line in service (SW1), the ATS changes over to the backup line (SW2) after a configurable time delay (T1).
[opening of SW1, closing of SW2]

The ATS does not change back to the main line, except in the event of a voltage loss on the backup line [opening of SW2, closing of SW1]

3 - Semi-Auto SW1 → SW2 or Semi-Auto SW2 → SW1

In the event of a voltage loss on the distribution line in service (SW1), the ATS changes over to the backup line (SW2) after an adjustable time delay (T1).
[opening of SW1, closing of SW2]

The ATS maintains the backup line in service (SW2) irrespective of the voltage on the two lines.

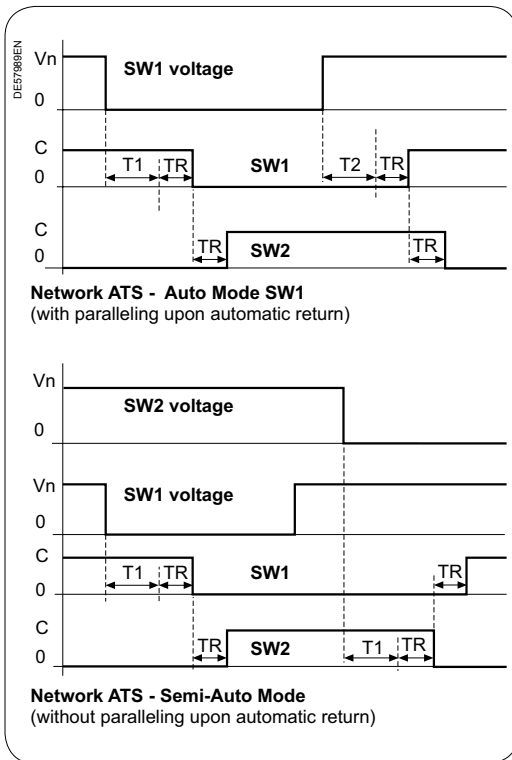

Characteristics

TR: switch response time (< 2 s).

- Time delay before changeover (T1)
Configurable from 0 s to 200 s in increments of 100 ms (factory setting = 1 s).
This time delay is also used to delay return to the initial channel in Semi-Auto mode SW1 ↔ SW2
- Time delay before return to the initial channel (T2) (Auto mode only)
Configurable from 0 s to 30 min. in increments of 5 s (factory setting = 15 s).

Automatic transfer systems

Generator ATS (1/2): changeover between a distribution system line and a generator.

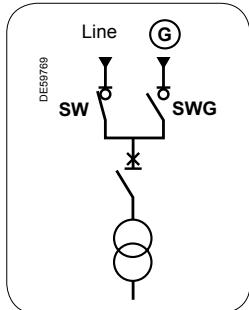

3 operating modes

1 - Auto SW mode

In the event of a voltage loss on the distribution line in service (SW), after a time delay T1, the ATS sends the opening command to SW and at the same time the Generator start-up order.

The remaining operation of the changeover sequence depends on the configuration of the "Generator channel closing" option:

- Case 1 "Generator channel closing after Generator power on": the Generator channel closing order is sent only when Generator voltage is detected.
- Case 2 "Generator channel closing after Generator start-up order": immediately after sending the Generator start-up order, the closing order is given to the Generator channel, without waiting until the Generator is actually started. [opening of SW, closing of SWG]

As soon as voltage returns on the main line (SW), after a time delay T2, the ATS changes back to the main line and the generator stoppage order is activated.

[opening of SWG, closing of SW if the paralleling option is not activated]
[closing of SW, opening of SWG if the paralleling option is activated]

2 - Semi-Auto SW↔SWG

The ATS does not change back to the main line, except in the event of a voltage loss on the generator due to generator stoppage or the opening of a switch upstream of the SWG channel.

3 - Semi-Auto SW→SWG

In the event of a voltage loss on the distribution line in service (SW), after a time delay T1, the ATS sends the opening command to SW and at the same time the Generator start-up order.

The remaining operation of the changeover sequence depends on the configuration of the "Generator channel closing" option:

- Case 1 "Generator channel closing after Generator power on"
- Case 2 "Generator channel closing after Generator start-up order" [opening of SW, closing of SWG]

The ATS maintains the backup line in service (SWG) and there is no automatic return.

Characteristics

TR: switch response time

- Time delay before changeover (T1): configurable from 0 s to 200 s in increments of 100 ms (factory setting = 1 s).

This time delay is also used to delay return to the initial channel in Semi-Auto mode SW↔SWG

- Time delay before return to the initial channel (T2)
- (Auto mode only). Configurable from 0 s to 30 min. in increments of 5 s (factory setting = 15 s).

- Tg1: Generator start-up, depending on the generator type, not configurable (max. waiting time: 60 s). If Tg1 is greater than 60 s, changeover is suspended.

- Tg2: Generator stoppage, depending on the generator type, not configurable (max. waiting time: 30 s).

Note: the generator stoppage command is sent 6 s after the end of changeover

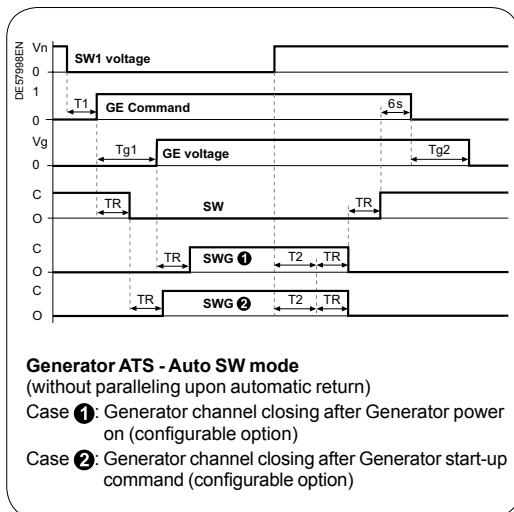

Automatic transfer systems

Bus tie coupling (2/3): source changeover between 2 incoming lines (SW1 and SW2) and a busbar coupling switch (SW3)

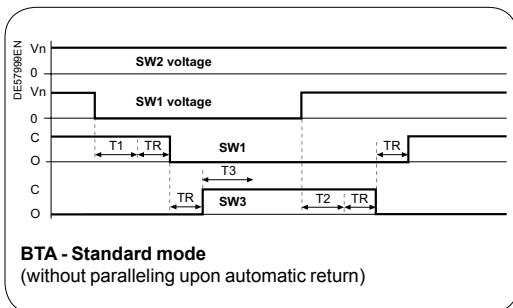
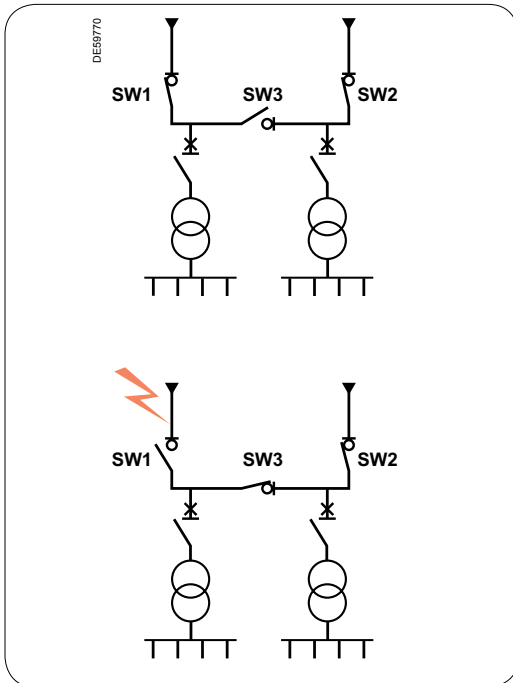

2 operating modes (selected from the Easergy T200 I configurator)

1 - Standard mode

In the event of a voltage loss on the distribution line in service (SW1), the ATS changes over to the backup line (SW2) after a configurable time delay (T1).

[opening of SW1, closing of SW3]

As soon as voltage returns on the main line (SW1), the ATS changes back to the main line after a time delay (T2).

[opening of SW3, closing of SW1 if the paralleling option is not activated]

[closing of SW1, opening of SW3 if the paralleling option is activated]

2 - Mode with locking upon voltage loss after changeover

In the event of a voltage loss on the distribution line in service (SW1), the ATS changes over to the backup line (SW2) after an adjustable time delay (T1).

[opening of SW1, closing of SW3].

Voltage presence is monitored during a configurable period T3. If the voltage disappears during this period, coupling switch SW3 is opened and the automatic transfer system is locked.

Characteristics

TR: switch response time (< 2 s).

- Time delay before changeover (T1)

Configurable from 100 ms to 60 s in increments of 100 ms (factory setting = 5 s).

- Time delay before return to the initial channel (T2)

Configurable from 5 s to 300 s in increments of 1 s (factory setting = 10 s).

- Monitoring time (T3)

Configurable from 100 ms to 3 s in increments of 100 ms (factory setting = 1 s).

Changeover conditions

- Validation of the ATS (from the configurator)

- The ATS is in operation (local control panel or remote control)

- The external closing digital input is OFF

- The switch for the main line is closed and the backup line switch is open

- No fault detected on the line in service

- The earthing switch is open on both switches.

Other functions

ATS in ON/OFF mode

The ATS system can be switched on or off from the local control panel (T200 I) or remotely (Scada system).

When the ATS is OFF, the RM6 switches can be electrically actuated by local or remote control (operation in parallel mode is therefore possible).

ATS in parallel mode upon Auto return

Activating this option enables paralleling of the channels by the automatic transfer system, during the phase of automatic return to the priority channel.

To be used when the ATS is in "Auto" mode.

Application: synchronization of the voltages of the main power supply line and the backup line allows return to the main line without any interruption.

Generator ON override command

Activation of the ATS and transfer on Generator can be activated upon an order: remotely or through dedicated digital input.

Applications:

- Periodic maintenance tests of the ATS/Generator system

- Switch on Generator when the Network is overloaded.

During peak hours, and if network is overloaded, Utility can send a remote order that will activate Generator. Having this facility, it will allow a private customer to negotiate better tariff of electricity.

Motorization - Switch, circuit breaker and fuse-switch combination

Motor mechanism

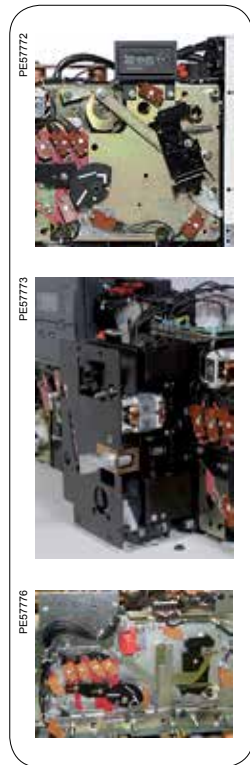

Switch operating mechanism

- The switch operating mechanism includes a space that is reserved for the installation of a geared motor. This can be installed at the factory, but it can also be installed on-site, by the customer, without de-energizing the unit, and without dismantling the operating mechanism.
- An electrical interlocking assembly prohibits any false operations.

Once motorized, the RM6 integrates perfectly into a telecontrol system

Circuit breaker and fuse-switch combination operating mechanism

- Circuit breaker or fuse protection functions can be motorized. Functional units of circuit breaker or fuse-switch protection can be equipped. The motorization can be installed at the factory, but it can also be installed on-site, by the customer, without de-energizing the unit, and without dismantling the operating mechanism.
- Electrical locking prohibits any false operations. This functionality is an option for circuit breaker and is by default for fuse-switch function. Once motorized, the RM6 integrates perfectly into a telecontrol system. This option becomes particularly useful in the context of the protection of a secondary ring, with supervision by a telecontrol system.

Unit applications

| Operating mechanism types | CIT | | CI1 | | CI1 | |
|---------------------------|------------|------------|-----------------|-------------|-------------------------|-------------|
| | Switch | | Circuit breaker | | Fuse switch combination | |
| Main circuit switch | Closing | Opening | Closing | Opening | Closing | Opening |
| Manual operating mode | Hand lever | Hand lever | Hand lever | Push button | Hand lever | Push button |
| Remote control option | Motor | Motor | Motor | Coil | Motor | Coil |
| Operating time | 1 to 2 s | 1 to 2 s | max. 13 s | 65 to 75 ms | 11 to 13 s | 60 to 85 ms |
| Earthing switch | Closing | Opening | Closing | Opening | Closing | Opening |
| Manual operating mode | Hand lever | Hand lever | Hand lever | Hand lever | Hand lever | Hand lever |

Motor option for switch-units and circuit breakers

The operating mechanism I, D, B and Q functions may be motorized

| | DC | | | | | | AC (50 Hz) * | |
|-------|-----------------------|-----|----|----|-----|-----|--------------|-----|
| | Un power supply (V)** | 24 | 48 | 60 | 110 | 125 | 220 | 120 |
| Power | (W) | 240 | | | | | | |
| | (VA) | | | | | | 280 | |

(*) Please consult us for other frequencies.

(**) At least a 20 A power supply is necessary when starting the motor.





accessories

accessories

Indication and tripping, DIN indicators, power supply, protection relay test, cable compartment, operating handle, key locking...

Contents

| | |
|---|-----|
| Indication and tripping | E-2 |
| DIN indicators | E-3 |
| Fault current and load current | E-3 |
| Fault current and voltage detection combination | E-3 |
| Other accessories | E-5 |
| Operating handle | E-6 |
| Key locking | E-7 |

Indication and tripping

Auxiliary contacts



- Each switch or circuit breaker can be fitted with 4 auxiliary contacts with the following positions: 2 NO and 2 NC.
- The earthing switch (except fuse-switch combination) can be fitted with 1 auxiliary contact with the following position: (opening/closing).
- Each circuit breaker can receive 1 auxiliary contact for tripping indication (protection by VIP).
- Each fuse-switch combination can be fitted with 1 blown fuse indication auxiliary contact.

Opening release



Each circuit breaker or fuse-switch combination can be fitted a switch-on opening release (shunt trip).

Opening release option for each circuit breaker or fuse-switch combination

| | | DC | | | | | | AC (50 Hz)* | |
|------------------------|------|-----|-----|-----|-----|-----|-----|----------------|-----|
| Un power supply | (V) | 24 | 48 | 60 | 110 | 125 | 220 | 120 | 230 |
| Power | (W) | 200 | 250 | 250 | 300 | 300 | 300 | | |
| | (VA) | | | | | | | 400 | 750 |
| Response time | (ms) | 35 | | | | | | 35 | |

(*) Please consult us for other frequencies

Undervoltage coil



Available on the circuit breaker function and on the combined fuse-switch, this trip unit causes opening when its supply voltage drops below a value under 35% of its rated voltage.

The time delay can be equipped with the undervoltage coil with the setting from 0.5 to 3 s.

| | | DC | | | | | | AC (50 Hz)* | |
|------------------------|----------------------|---------------------|----|----|-----|-----|-----|----------------|-----|
| Un power supply | (V) | 24 | 48 | 60 | 110 | 125 | 220 | 120 | 230 |
| Power | | | | | | | | | |
| | Excitation (W or VA) | 200 (during 200 ms) | | | | | | 200 | |
| | Latched (W or VA) | 4.5 | | | | | | 4.5 | |
| Threshold | | | | | | | | | |
| | Opening | 0.35 to 0.7 Un | | | | | | 0.35 to 0.7 | |
| | Closing | 0.85 Un | | | | | | 0.85 | |

(*) Please consult us for other frequencies

DIN indicators - Fault current and load current Fault current and voltage detection combination

Increase your power availability with the indicators suitable for the location of fault and MV network load management. Available in DIN format which provides easy installation in RM6.

Each switch function on RM6 switchboard can be equipped independently from other functional unit with:

- Fault current indicator
- Ammeter
- Voltage detector.



An advanced range of FPI having Voltage detection, programmable voltage presence/absence relays with Modbus communication having the capability to work on all types of neutral networks. An easy solution for Smart Grid.

Flair Fault Passage Indicator

Built in Voltage Presence/ Absence relays: 2 output contacts, configurable.
Fault detection for compensated and isolated networks requires a VPIS_VO for whole range except Flair 21D.

Fault current indicator

The updated Easergy Flair 21D - 22D - 23D - 23DM is a family of fault passage indicators in DIN format, efficient, self-powered and self adapted to the network providing hassle free installation. Capable to work on all types of neutral networks. Well equipped with LCD for better visibility of detailed parameters having an option of external outdoor lamp indication.

Functions

- Indication of phase-phase and phase-earth faults
- Display of parameters & settings
- Display of the faulty phase
- Display of load current, maximum current for each phase, frequency and direction of flow of energy
- Fault passage indication and voltage detection combination (only Flair 23D)

Easy and reliable to use

- Automatic setting on site
- Fault indication by LED, LCD and outdoor light indicator (optional)
- Battery life of 15 years (Flair 22D)
- Accurate Fault detection by validation of fault with voltage loss using VPIS (except Flair 21D)
- Possible to be mounted on RM6 in factory or to be added on site
- Adaptation on site can be facilitated by using the current sensor of split type, without removing MV cables.



RM6 can also be provided with Alpha M or Alpha E (Hortzmann) type short-circuit indicators.



Load current indicator

The ammeter **Amp21D** of Easergy range is dedicated to Medium Voltage network load monitoring.

Functions

- Display of 3 phase current: I1, I2, I3
- Display of the maximum current: I1, I2, I3.

Easy and reliable to use

- Automatic setting on site
- Possible to be mounted on RM6 in factory or to be added on site
- Adaptation on site can be facilitated by using the current sensor of split type, without removing MV cables.



Voltage detection relay

Flair23DM: An advanced range of FPI having Voltage detection, programmable voltage presence/ absence relays with Modbus communication having the capability to work on all types of neutral networks. An easy solution for Smart Grid.

- Combination fault passage indicator and voltage detector.
- Ideal for use with an Automatic Transfert of Source System.
- Needs a stabilised external DC power supply to supply power to the Flair 23DM.
- Requires the VPIS-VO option on the VPIS for interfacing with it, in order to acquire the image of the mains voltage.
- With the communication option it is the ideal detector to be integrated in the cell as a communicating fault detector.

DIN indicators - Fault current and load current Fault current and voltage detection combination

Characteristics

| | | Flair 21D | Flair 22D & 23D | Flair 23DM |
|--|--|--|--|---|
| Frequency (auto-detection) | | 50 Hz and 60 Hz | 50 Hz and 60 Hz | 50 Hz and 60 Hz |
| Operating voltage | | Un: 3 to 36 kV - Vn: 1,7 to 24 kV | Un: 3 to 36 kV - Vn: 1,7 to 24 kV | Un: 3 to 36 kV - Vn: 1,7 to 24 kV |
| Neutral | Phase-to-phase fault | All systems | All systems | All systems |
| | Phase-to-earth fault | Impedance-earthed, directly earthed | Impedance-earthed, directly compensated, isolated Flair 22D: (type B), Flair 23D, type (B,C) (4) | |
| Measurements | | | | |
| Load | Minimum current | > 2 A | > 2 A | > 2 A |
| Current (A) (resolution 1 A) | For each phase Accuracy: $\pm (2\% + 2 \text{ digits})$ | Ammeter Maximeter | Ammeter Maximeter | OFF or AUTO or 100 to 800 A (50A increments) |
| Voltage (% of rated voltage) | With VPIS-VO option Accuracy: $\pm 1\%$ | | | Phase-to-neutral or phase-to-phase voltage |
| Fault detection | | | | |
| Threshold configuration | | Via microswitches | Via front panel buttons | Via front panel buttons |
| Overcurrent fault Accuracy $\pm 10\%$ | Auto-calibration | Yes | Yes | Yes |
| | Thresholds | AUTO or 200, 400, 600, 800 A | OFF or AUTO or 100 to 800 A (50 A increments) | OFF or AUTO or 100 to 800 A (50 A increments) |
| Earth fault With 3 phase CTs Accuracy $\pm 10\%$ | Auto-calibration | Yes | Yes | Yes |
| | Algorithm | $\Sigma 3I + di / dt$ | $\Sigma 3I + di / dt$ | $\Sigma 3I + di / dt$ |
| | Thresholds | OFF or AUTO or 40, 60, 80, 100, 120, 160 A | OFF or 5 (2) to 30 A (5 A increments) and 30 to 200 A (10 A increments) | |
| Earth fault With zero sequence CT Accuracy $\pm 10\%$ or $\pm 1 \text{ A}$ | Auto-calibration | - | No | No |
| | Thresholds | - | OFF or AUTO (5) or 5 to 30 A (5 A increments) and from 30 to 200 A (10 A increments) (1) | |
| Fault acknowledge time delay | | 60 ms | | |
| Fault confirmation time delay | | 70 s | 3 s, 70 s or OFF | |
| Inrush | Time delay | | 3 s, 70 s or OFF | |
| Reset | Automatic | Upon current return 2 A (70 s or OFF) | Upon current return 2 A (3 s, 70 s or OFF) | |
| | Manual via front panel | Yes | Yes | Yes |
| | External contact | Yes | Yes | Yes |
| | Deferred | 4 h | 1, 2, 3, 4, 8, 12, 16, 20, 24 h. Factory setting = 4 h | |
| Indications | LED | Yes | Yes | Yes |
| | External contact | Yes | Yes | Yes |
| | External indicator lamp | Yes (with battery) | Yes (without battery) | Yes (without battery) |
| | Phase indication | Yes | Yes | Yes |
| Communication | | | | |
| RS485 2-wire, connector with LEDs | | No | No | Yes |
| Speed: auto-detection 9600, 19200, 38400 bits/s - Class A05 | | | | |
| Accessible data: Phase and earth faults; Fault passage counters including transient faults; Current measurements (I1, I2, I3, I0), max. current, voltage (U, V, residual); Resetting of fault indication, counters and max. values; Fault and voltage presence/absence detection parameters; Communication parameters; Time synchronisation and time-tagged events | | | | |
| Power supply | | | | |
| Self-powering | On measuring CTs | Yes (I load > 3 A) | Yes | Yes |
| Battery (Service life: 15 years) | | No | Lithium (Flair 22D), No (Flair 23D) | No |
| External power supply | | No | No (Flair 22D), 24 to 48 Vcc (Conso mac: 50 mA) (Flair 23D) | 24 to 48 Vdc (conso mac: 50 mA) |
| Display | | | | |
| Display | | 4-digits LCD | 4-digits LCD | 4-digits LCD |
| Fault | | Red LED | Red LED | Red LED |
| Phase at fault | | Yes | Yes | Yes |
| Setting | | Yes (CT type) | Yes | Yes |
| Sensors | | | | |
| Phase CT | | 3 phase CTs | 2 or 3 phase CTs | 2 or 3 phase CTs |
| Zero sequence CT | | No | Diameter: 170 mm | Diameter: 170 mm |
| Test mode | | | | |
| By button on front panel | | Product name - Software version - Network frequency - Residual current - Digits test | Product name - Software version - Network frequency - Residual current - VPIS presence - Direction of energy - Digits test | |

(1) The minimum threshold 5 A can only be reached with the earth CT ref CTRH2200.

(2) 20 A minimum for resistive neutral type, 5A minimum for isolated or compensated neutral type

(3) Flair 23D & Flair 23DM: Launched in 2013.

(4) Type C mounting is not available on compensated neutral

(5) only with isolated and compensated neutral

Other accessories

Phase concordance unit

This unit is used to check phase concordance.



Protection relay test

This unit is used to power the VIP 40, VIP 45, VIP 400 and VIP 410 units, making it possible to operate and test the protection system. It can also be used to power and test Schneider Electric LV circuit breakers.



Options for cable compartment

Standard equipment:

- A closing panel
- Cable binding
- Connection of cable earthing.

Optional equipment:

- Panel with window to display liquid type overcurrent indicators installed around the cables
- Deeper panel to enable to adding of a lightning arrester
- ESw interlocking to prohibit access to the connection compartment when the earthing switch is open
- LBSw or CB interlocking to prohibit closing of the switch or circuit breaker when the connection compartment panel is open
- Internal arc withstand for the cable compartment up to 20 kA 1s.



PS100 high-availability power supply

The PS100 is associated with a backup battery, ensuring the uninterrupted power supply up to 48 hours in the event of micro outages and power interruptions.

The battery is a standard sealed lead-acid 12 Vdc battery with a 10-year service that can be purchased easily anywhere in the world.

The backup solution with PS100 allows an easy maintenance with only one battery and withstands harsh substation environments.

The PS100 backup power supply unit:

Reserves an "additional energy backup" to restart the installation after an extended power interruption

- Includes a regulated and temperature-compensated charger
- Stops the battery before deep discharge
- Carries out a battery check every 12 hours
- Measures battery ageing
- Forwards monitoring information via a modbus communication port and output relays, which allows the preventive battery replacement before the end of its life.

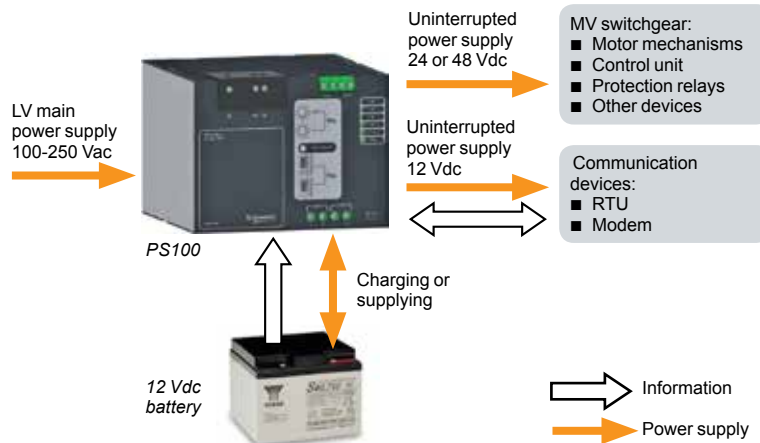

VRT7 auxiliary power supply

- A phase-to-phase screened voltage transformer.
- Compact dimensions and screened design for easy installation; insensitivity to harsh environments.
- Designed to withstand power frequency tests (no need for disconnection during commissioning)
- Power: 300 VA continuous, 500 VA for 1 mn.



| | | | | | |
|--------------------------|---------------|---------------|--------------|--------------|---------------|
| Voltages* (kV) | 7.2 - 20 - 60 | 7.2 - 32 - 60 | 12 - 28 - 75 | 12 - 42 - 75 | 24 - 50 - 125 |
| Primary (kV) | 6 & 6.6 | 6 | 10 - 11 | 10 | 13.8 - 15 |
| Secondary (V) | 230 | | | | |
| Power and accuracy class | 30 VA cl. 3 | | | | |

* Rated Voltage -Rated power-frequency withstand voltage kVms- Rated lightning impulse withstand voltage kV peak

Operating handle

3 types of operating handle (standard, longer and super long) are proposed in RM6 offer for different combination of cubicles.

The longer operating handle is necessary:

- For RM6 of with 2, 3, 4 or 5 functions, when circuit breaker is motorized and is on the left side of switch function

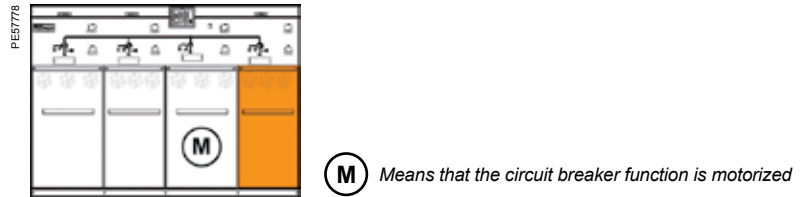

- For RM6 of 1 function extensible, when circuit breaker is motorized and is on the left side of a fuse-switch function

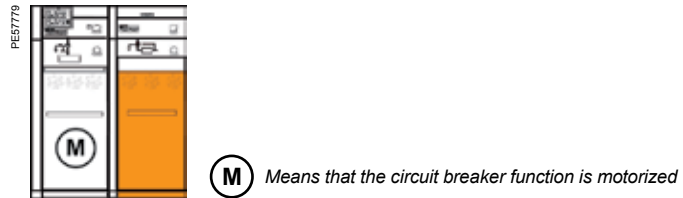

The super long operating handle is necessary:

- For RM6 of 1 function extensible, when circuit breaker is manual and is on the left side of a fuse-switch function

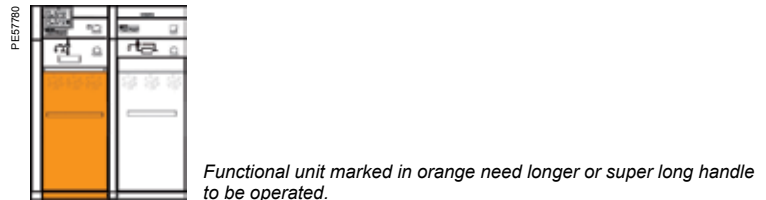

- For RM6 of 1 function extensible, when two fuse-switch functions are connected

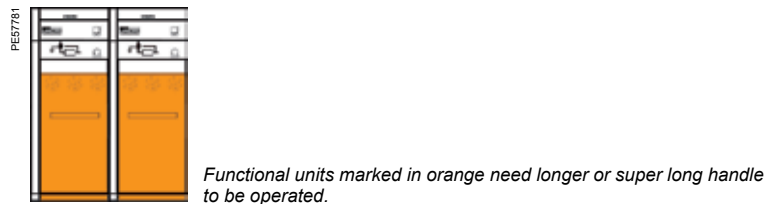

- For DE-Q, DE-D, DE-B, DE-Bc, when the metering cubicle DE-Mt is on its right side

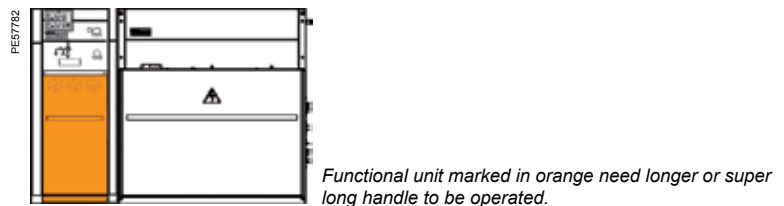

The standard operating handle

For all other possible cubicle combinations, the standard operating handle is enough to operate the RM6 switchgears.

Key locking

MT55154



The markings (O, S, and X) are engraved on the keys and the locks. They are given here only as an aid to understanding of the diagrams. When the switchgear is locked in the “open” position, the remote control can't work.

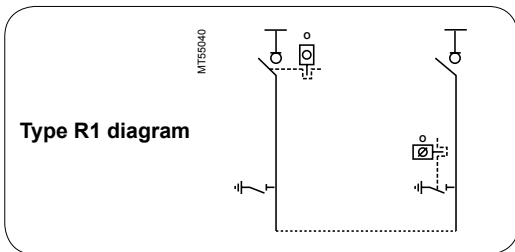

On network switches or 630 A circuit breaker feeder

Semi-crossed locking

- Prohibits the closing of the earthing switch of the downstream switchgear unless the upstream switchgear is locked in the “open” position

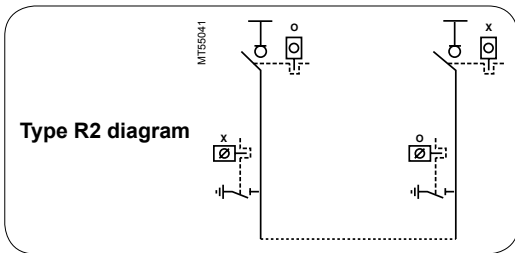

Crossed locking

- Prohibits closing of the earthing switches unless the upstream and downstream switchgear is locked in the “open” position.

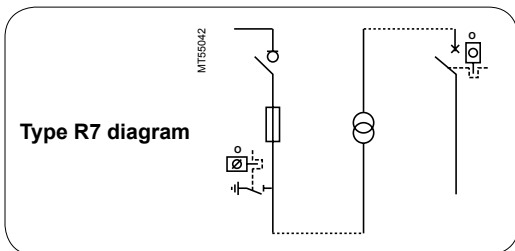

On transformer feeders

RM6/transformer

- Prohibits access to the transformer unless the earthing switch has been locked in the “closed” position.

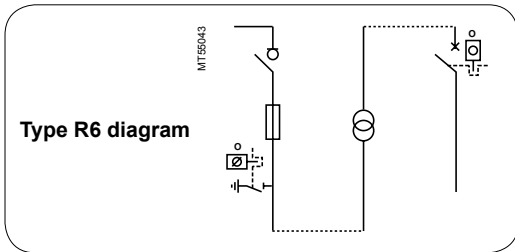

RM6/low voltage

- Prohibits closing of the earthing switch and access to any protection unit fuses unless the main LV circuit breaker has been locked in the “open” or “disconnected” position.

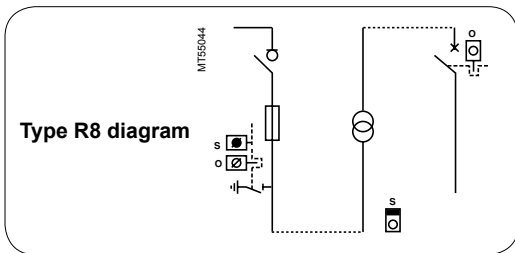

RM6/transformer/low voltage

- Prohibits closing of the earthing switch and access to any protection unit fuses unless the main LV circuit breaker has been locked in the “open” or “disconnected” position.
- Prohibits access to the transformer unless the earthing switch has already been “closed”.

: no key
 : free key
 : captive key



connection

connection

Selecting bushings and connectors,
cable and other compatible
connections...

Contents

| | |
|---------------------------------------|------------|
| Selecting bushings and connectors | F-2 |
| Compatible cable connections | F-3 |
| Other types of compatible connections | F-5 |

Selecting bushings and connectors

General

- The profiles, contacts and dimensions of the RM6 connection interfaces are defined by the IEC 60137 standard.
- 100% of the epoxy resin interfaces undergo dielectric testing at power frequency and partial discharge tests.
- An insulated connector must be used in order to guarantee the dielectric performance over time. Schneider Electric recommends using nkt connectors.

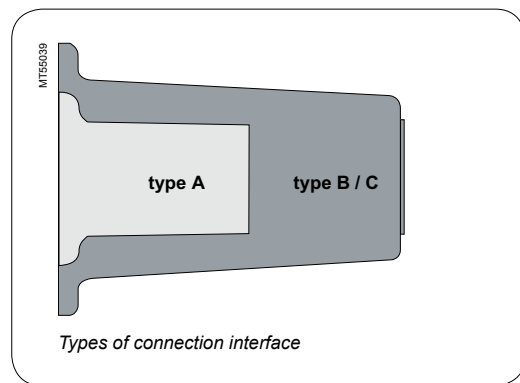

Appropriateness for use

The bushings carry the electrical current from the outside to the inside of the enclosure, which is filled with SF6 gas, ensuring insulation between the live conductors and the frame.

There are 3 types of bushing, which are defined by their short-time withstand current:

- Type A: 200 A: 12.5 kA 1 s and 31.5 kA peak (plug-in)
- Type B: 400 A: 16 kA 1 s and 40 kA peak (plug-in)
- Type C: 630 A: 25 kA 1 s, 21 kA 3 s and 62.5 kA peak (disconnectable M16).

How to define the connection interface

The connection interfaces depend on specific criteria, such as:

Installation

- Current rating of the connected equipment: 200, 400, 630 A
- Short-time withstand current for 12.5 kA, 16 kA, 25 kA switch and circuit breaker functions
- For the fuse-switch combination function, as the short-circuit current is limited by the fuse, the connection interface will be of type A (200 A)
- Minimum phase expansion length
- Connection type:
 - plug in: multicontact ring
 - disconnectable: bolted.
- Output position: straight, elbow.

Cable

- Specified voltage:
 - of the cable
 - of the network.
- Type of conductor:
 - aluminium
 - copper.
- Cross section in mm²
- insulation diameter
- Cable composition:
 - single-core
 - 3-core.
- Insulation type:
 - dry
 - paper impregnated (non-draining type).
- Type of screen
- Armature.

This information must be specified for better definition of the connection interfaces.

Compatible cable connections

Type A bushing

Directed field plug-in connector
Dry single-core cable

| Performance | Connection | Supplier | Reference | Cross section | Remarks |
|--|------------|-----------------|---------------|---------------|---------------------------|
| 7.2 to 10 kV 200 A -95 kV impulse | Plug-in | Elastimold | 158LR | 16 to 120 | T-shaped elbow |
| | | Elastimold | 151SR | 16 to 120 | Straight, Q function only |
| | | Prysmian | FMCE 250 | 16 to 95 | |
| 7.2 to 17.5 kV 200 A -95 kV impulse | Plug-in | nkt cables GmbH | EASW 12/250 A | 25 to 95 | Shaped elbow |
| | | nkt cables GmbH | EASG 12/250 A | 25 to 95 | Straight |
| | | Tycoelectronics | RSES-52xx | 25 to 120 | Shaped elbow |
| | | Tycoelectronics | RSSS-52xx | 25 to 95 | Straight connection |
| 7.2 to 24 kV 200 A -125 kV impulse | Plug-in | Elastimold | K158LR | 16 to 95 | T-shaped elbow |
| 24 kV 200 A -125 kV impulse | Plug-in | nkt cables GmbH | EASW 20/250 A | 25 to 95 | Shaped elbow |
| | | nkt cables GmbH | EASG 20/250 A | 25 to 95 | Straight |
| | | Tycoelectronics | RSES-52xx | 25 to 120 | Shaped elbow |
| | | Tycoelectronics | RSSS-52xx | 25 to 95 | Straight connection |

Type A/M8 bushing

Non-directed field disconnectable connector (*)
Dry single and 3-core cable

| Performance | Connection | Supplier | Reference | Cross section | Remarks |
|--|------------------|-----------------|--------------------|---------------|---------|
| 7.2 to 17.5 kV 200 A -95 kV impulse | Heat shrinkable | Tycoelectronics | EPKT + EAKT + RSRB | 16 to 150 | |
| | Insulating boots | Kabeldon | KAP70 | 70 max. | |

(*) 520 mm plinth must be used

Type B bushing

Directed field plug-in connector
Dry single-core cable

| Performance | Connection | Supplier | Reference | Cross section | Remarks |
|---------------------------------------|------------|-----------------|-----------|---------------|-----------------------|
| 7.2 to 10 kV 400 A-95 kV impulse | Plug-in | Elastimold | 400 LR | 70 to 240 | Limited to Us = 10 kV |
| 7.2 to 17.5 kV 400 A-95 kV impulse | Plug-in | nkt cables GmbH | CE 12-400 | 25 to 300 | |
| | | Tycoelectronics | RSES-54xx | 25 to 300 | Shaped elbow |
| 24 kV 400 A-125 kV impulse | Plug-in | Prysmian | FMCE 400 | 70 to 300 | |
| | | Elastimold | K400LR | 35 to 240 | |
| | | Kabeldon | SOC 630 | 50 to 300 | |
| | | nkt cables GmbH | CE 24-400 | 25 to 300 | |
| | | Tycoelectronics | RSES-54xx | 25 to 300 | Shaped elbow |

For cross section > 300 mm², please consult us.

Compatible cable connections

Type C bushing

Directed field disconnectable connector Dry single-core cable

| Performance | Connection | Supplier | Reference | Cross section | Remarks |
|---------------------------------------|----------------|-----------------|-----------|---------------|----------------------|
| 7.2 to 10 kV 630 A-95 kV impulse | Disconnectable | Elastimold | 440 TB | 70 to 240 | |
| 7.2 to 17.5 kV 630 A-95 kV impulse | Disconnectable | nkt cables GmbH | CB 12-630 | 25 to 300 | |
| | | Tycoelectronics | RSTI-58xx | 25 to 300 | "T"-shaped connector |
| 7.2 to 24 kV 630 A-125 kV impulse | Disconnectable | Prysmian | FMCTs 400 | 70 to 300 | |
| | | Elastimold | K400TB | 35 to 240 | |
| | | Kabeldon | SOC 630 | 50 to 300 | |
| 24 kV 630 A-125 kV impulse | Disconnectable | nkt cables GmbH | CB 24-630 | 25 to 300 | |
| | | Tycoelectronics | RSTI-58xx | 25 to 300 | "T"-shaped connector |

Non-directed field disconnectable connector Dry single and three-core cable

| Performance | Connection | Supplier | Reference | Cross section | Remarks |
|--------------------------------------|---------------------------|-----------------|--------------------|-----------------------|--|
| 7.2 to 10 kV 630 A -95 kV impulse | Heat shrinkable | Tycoelectronics | EPKT + EAKT + RSRB | 16 to 300 | |
| | | Sigmaform | Q-CAP | 16 to 300 | |
| | Insulating boots | Kabeldon | SOC 630 | 50 to 300 | Completed by a kit for three core-pole cable |
| | Simplified disconnectable | Tycoelectronics | RICS + EPKT | 25 to 300 | |
| Euromold | | 15TS-NSS | 50 to 300 | Limited to Us = 20 kV | |
| 24 kV 630 A -125 kV impulse | Disconnectable | nkt cables GmbH | AB 12-630 | 25 to 300 (+ATS) | For 3-core cable |
| | Simplified disconnectable | Tycoelectronics | RICS + EPKT | 25 to 300 | |

Non-directed field disconnectable connector Single-core cable, paper impregnated, non-draining type

| Performance | Connection | Supplier | Reference | Cross section | Remarks |
|---------------------------------------|---------------------------|-----------------|----------------|---------------|---------|
| 7.2 to 17.5 kV 630 A-95 kV impulse | Insulating boots | Kabeldon | SOC | 25 to 300 | |
| | Simplified disconnectable | Tycoelectronics | RICS - EPKT | 25 to 300 | |
| | Heat shrinkable | Tycoelectronics | EPKT+EAKT+RSRB | 95 to 300 | |
| 24 kV 630 A-125 kV impulse | Simplified disconnectable | Tycoelectronics | RICS - EPKT | 25 to 300 | |

Non-directed field disconnectable connector Three-core cable, paper impregnated, non-draining type

| Performance | Connection | Supplier | Reference | Cross section | Remarks |
|---------------------------------------|---------------------------|-----------------|----------------|---------------|---------|
| 7.2 to 17.5 kV 630 A-95 kV impulse | Insulating boots | Kabeldon | SOC 630 | 25 to 300 | |
| | Simplified disconnectable | Tycoelectronics | RICS - EPKT | 25 to 300 | |
| | Heat shrinkable | Tycoelectronics | EPKT+EAKT+RSRB | 16 to 300 | |
| 24 kV 630 A-125 kV impulse | Simplified disconnectable | Tycoelectronics | RICS - EPKT | 25 to 300 | |

For cross section > 300 mm², please consult us.

Other types of compatible connections

Connectors with lightning arrestors

Disconnectable connector

Single-core dry cable and lightning arrester

| Performance | Connection | Supplier | Reference | Cross section | Remarks |
|---|----------------|-----------------|------------------------------------|---------------|----------------------------------|
| 7.2 to 17.5 kV 630 A-95 kV impulse | Disconnectable | nkt cables GmbH | AB 12-630 + ASA12 (5 or 10 kA) | 25 to 300 | Non-directed field |
| | | | CB 24-630 + CSA 24 (5 or 10 kA) | 25 to 300 | Directed field |
| 24 kV 630 A-125 kV impulse | Disconnectable | nkt cables GmbH | AB 12-630 + ASA12 (5 or 10 kA) | 25 to 300 | Non-directed field |
| | | | CB 24-630 + CSA 24 (5 or 10 kA) | 25 to 300 | Directed field |
| 7.2 to 17.5 kV 630 A-95 kV impulse | Disconnectable | Tycoelectronics | RICS+EPKT RDA 12 or 18 | 25 to 300 | |
| | | Elastimold | K400TB + K400RTPA + K156SA | 35 to 300 | Cable box enlarged |
| 24 kV 630 A-125 kV impulse | Disconnectable | Tycoelectronics | RICS + EPKT RDA 24 | 25 to 300 | |
| | | Elastimold | K440TB + K400RTPA + K156SA | 35 to 300 | Cable box enlarged |
| | | Tycoelectronics | RSTI-58 + RSTI-CC- 58SAxx05 | 25 to 300 | Directed field 5 kA arrester |
| | | Tycoelectronics | RSTI-58 + RSTI-CC- 66SAxx10M16 | 25 to 300 | Directed field 10 kA arrester |

For cross section > 300 mm², please consult us.



installation

installation

Dimensions and installation conditions,
civil works...

Contents

| | |
|--|------------|
| Dimensions and installation conditions | G-2 |
| Civil works | G-6 |

Dimensions and installation conditions

1 function modules

| | Function | Weight (kg) | Length (mm) |
|--------------------|----------|-------------|--------------------------|
| Regular RM6 | | | |
| NE | I | 135 | L = 572 |
| | D | | L = 572 |
| | B | | L = 572 |
| DE | I | 135 | L' = 472 + 30 + 30 = 532 |
| | D | | L' = 572 + 30 + 30 = 632 |
| | B | | L' = 572 + 30 + 30 = 632 |
| | Q | | L' = 472 + 30 + 30 = 532 |
| RE | O | 135 | L' = 472 + 30 = 502 |
| LE | | | L' = 472 + 30 = 502 |
| DE | | | L' = 472 + 30 + 30 = 532 |
| DE | Ic | 145 | L' = 572 + 30 + 30 = 632 |
| | Bc | | L' = 572 + 30 + 30 = 632 |

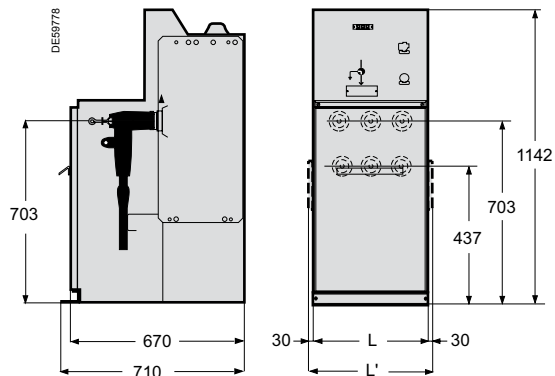

2 functions modules

| | Function | Weight (kg) | Length (mm)* |
|-----------------------------|----------|-------------|----------------------------|
| Regular RM6 | | | |
| NE | QI | 180 | L = 829 |
| | DI, BI | | L = 829 |
| | II | | L = 829 |
| RE | II | 155 | L' = 829 + 30 = 859 |
| RM6 Free Combination | | | |
| NE | | | L = 1052 |
| LE | | | L' = 1052 + 30 = 1082 |
| RE | | | L' = 1052 + 30 = 1082 |
| DE | | | L' = 1052 + 30 + 30 = 1112 |

* Dimensions only for RM6 Free combination

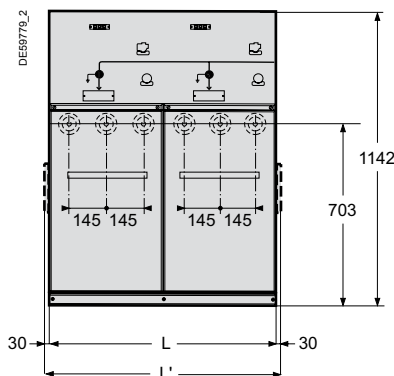

3 functions modules

| | Function | Weight (kg) | Length (mm) |
|--|----------|-------------|----------------------------|
| Regular RM6 | | | |
| NE | IQI | 275 | L = 1186 |
| | III | 240 | L = 1186 |
| | IDI | | L = 1186 |
| | IBI | 250 | L = 1186 |
| RE | IQI | 275 | L' = 1186 + 30 = 1216 |
| | III | 240 | L' = 1186 + 30 = 1216 |
| | IDI | | L' = 1186 + 30 = 1216 |
| | IBI | 250 | L' = 1186 + 30 = 1216 |
| DE | IQI | 275 | L' = 1186 + 30 + 30 = 1246 |
| | III | 240 | L' = 1186 + 30 + 30 = 1246 |
| | IDI | | L' = 1186 + 30 + 30 = 1246 |
| | IBI | 250 | L' = 1186 + 30 + 30 = 1246 |
| RM6 Free Combination | | | |
| NE | | | L = 1532 |
| LE | | | L' = 1532 + 30 = 1562 |
| RE | | | L' = 1532 + 30 = 1562 |
| DE | | | L' = 1532 + 30 + 30 = 1592 |
| RM6 Free Combination with bus coupler | | | |
| RE | | | L' = 1532 + 30 = 1562 |
| DE | | | L' = 1532 + 30 + 30 = 1592 |

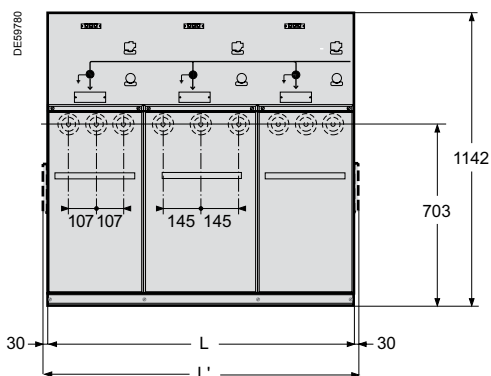

Type of tank

- NE: non-extensible
- RE: extensible to the right
- LE: extensible to the left
- DE: extensible module to the right or left (one function)

Dimensions and installation conditions

4 functions modules

| | Function | Weight (kg) | Length (mm) |
|--------------------|----------|-------------|----------------------------|
| Regular RM6 | | | |
| NE | IIQI | 355 | L = 1619 |
| | IIII | 320 | L = 1619 |
| | IIDI | 330 | L = 1619 |
| | IIBI | 330 | L = 1619 |
| | QIQI | 390 | L = 1619 |
| | BIBI | 340 | L = 1619 |
| RE | IIQI | 355 | L' = 1619 + 30 = 1649 |
| | IIII | 320 | L' = 1619 + 30 = 1649 |
| | IIDI | 330 | L' = 1619 + 30 = 1649 |
| | IIBI | 330 | L' = 1619 + 30 = 1649 |
| | QIQI | 390 | L' = 1619 + 30 = 1649 |
| | DIDI | 340 | L' = 1619 + 30 = 1649 |
| DE | IIQI | 355 | L' = 1619 + 30 + 30 = 1679 |
| | IIII | 320 | L' = 1619 + 30 + 30 = 1679 |
| | IIDI | 330 | L' = 1619 + 30 + 30 = 1679 |
| | IIBI | 330 | L' = 1619 + 30 + 30 = 1679 |

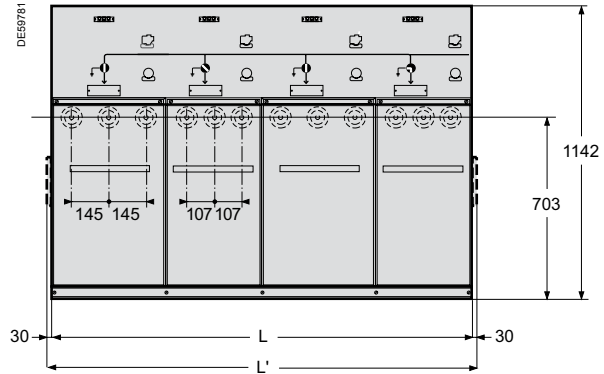

5 functions modules

| | Function | Weight (kg) | Length (mm) |
|--------------------|----------|-------------|----------------------------|
| Regular RM6 | | | |
| NE | IDIDI | 470 | L = 2000 |
| | IQIQI | 520 | L = 2000 |
| | IBIQI | 495 | L = 2000 |
| RE | IDIDI | 475 | L' = 2000 + 30 = 2030 |
| | IIIII | 455 | L' = 2000 + 30 = 2030 |
| DE | IDIDI | 480 | L' = 2000 + 30 + 30 = 2060 |
| | IIIQI | 495 | L' = 2000 + 30 + 30 = 2060 |

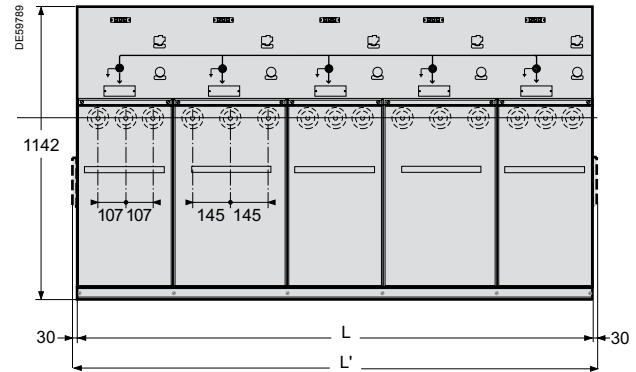

Metering cubicle

| | Function | Weight (kg) | Length (mm) |
|--|----------|-------------|-------------|
| RM6 metering cubicle with LV compartment | | | |
| DE | DE-Mt | 420 | L = 1106 |
| RM6 metering cubicle without LV compartment | | | |
| DE | DE-Mt | 400 | L = 1106 |

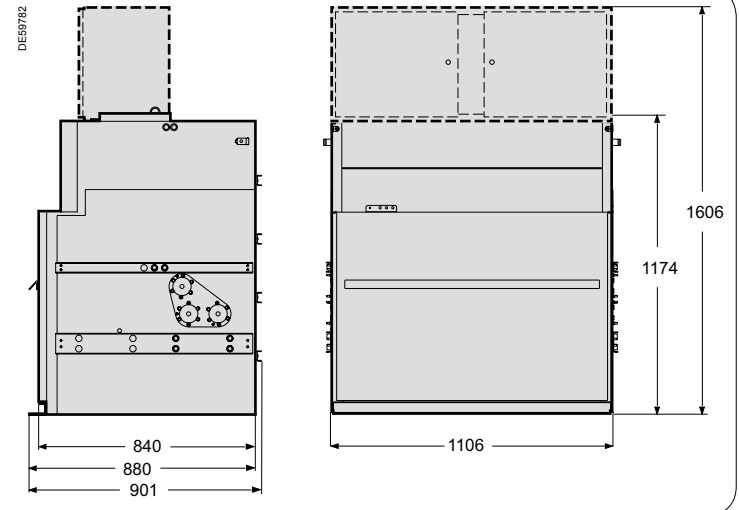

Arrester option

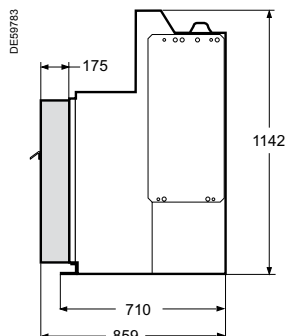

Dimensions and installation conditions

Dimensions of RM6 REs with an extension module

| Nb of RE units | DE single unit type | A Length (mm) |
|--|---------------------|---------------|
| RM6 standard functional units | | |
| 2 units | Type 1 | 1374 |
| | Type 2 | 1474 |
| 3 units | Type 1 | 1731 |
| | Type 2 | 1831 |
| 4 units | Type 1 | 2164 |
| | Type 2 | 2264 |
| RM6 Free Combination functional units | | |
| 2 units | Type 1 | 1597 |
| | Type 2 | 1697 |
| 3 units | Type 1 | 2077 |
| | Type 2 | 2177 |

(*) B = 900 for 1 DE function
 B = 1600 for 3 DE functions
 B = 2000 for 4 DE functions
 These dimensions can be reduced under special conditions, consult us.

For reminder see the only one restriction of installation on standard range (see page A-5). For standard range, as a rule, the installation is made from left to right by leaving of the heaviest station.

Layout

Floor mounting

The RM6 is supported by 2 metal feet with holes for mounting:

- on a flat floor fitted with trenches, passages or ducts
- on concrete footing
- on studs
- on metal rails etc.

| Possibilities to add cubicle | 1 st position | 2 nd position | 3 rd position | Last position |
|------------------------------|--------------------------|--------------------------|--------------------------|---------------|
| ∅ | RE-x | DE-x | DE-x | LE-x |
| RE-x* | DE-x | DE-x | LE-x | ∅ |

* It is not possible to add RE-x if switchboard with a station DE is in first position

Standard non-extensible RM6 (top view)

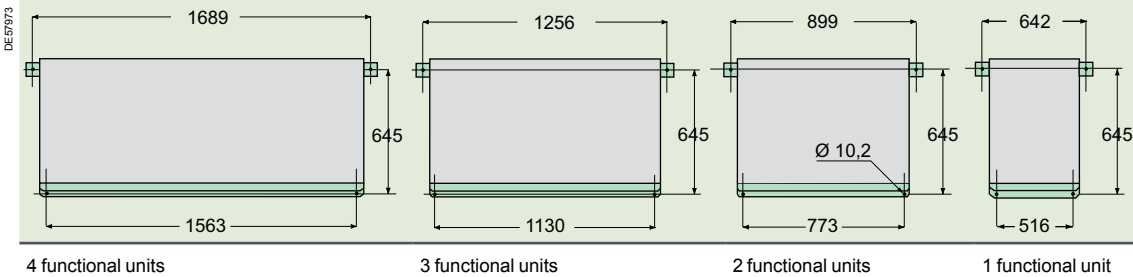

Extensible RM6 (top view)

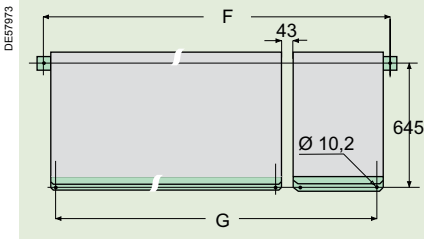

3 or 4 functional units with extensibility module

RM6 Free Combination (top view)

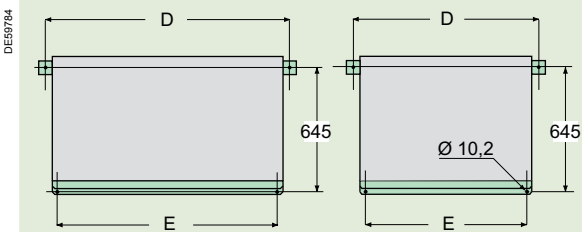

3 functional units 2 functional units

| Nb of RE units | DE single unit type | Length (mm) | |
|--|---------------------|-------------|------|
| | | F | G |
| RM6 standard functional units | | | |
| 2 units | Type 1 | 1414 | 1288 |
| | Type 2 | 1514 | 1388 |
| 3 units | Type 1 | 1771 | 1645 |
| | Type 2 | 1871 | 1745 |
| 4 units | Type 1 | 2204 | 2078 |
| | Type 2 | 2304 | 2178 |
| RM6 Free Combination functional units | | | |
| 2 units | Type 1 | 1637 | 1511 |
| | Type 2 | 1737 | 1611 |
| 3 units | Type 1 | 2117 | 1991 |
| | Type 2 | 2217 | 2091 |

| Nb of units | Length (mm) | |
|--|-------------|------|
| | D | E |
| RM6 Free Combination functional units | | |
| 2 units | 1122 | 996 |
| 3 units | 1602 | 1476 |

Dimensions and installation conditions

Wall mounting

There are two holes allowing the unit to be fixed on the wall as well as mounted on the floor.

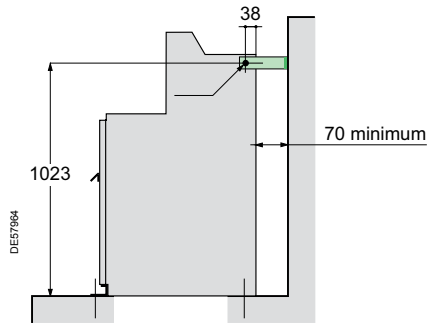

Ceiling clearance

For substations with fuse-holders, provide a minimum ceiling clearance of 1200 mm.

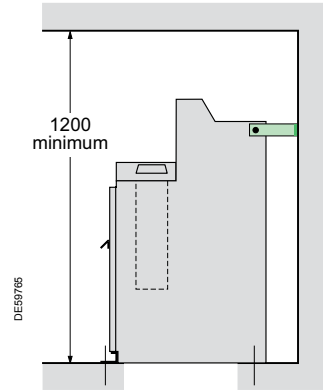

Installation of the substation for internal arc withstand

When there is a requirement for installations with protection against internal arc faults, refer to the following diagrams.

Gas removal to the rear

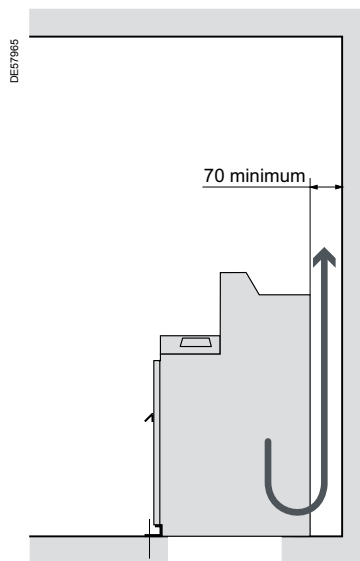

Gas removal to the bottom

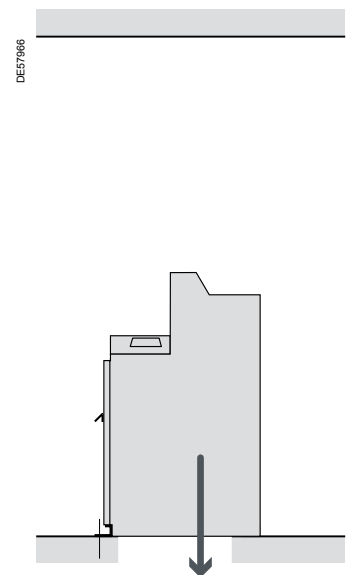

N.B.: parts for guiding the gases to vent openings and cooling walls are not part of the switchgear supply. These must be adapted to each specific case.

Civil works

For connection to “network” or “transformer” via circuit breaker

The “network” cables can be run either:

- through trenches, passages, ducts
- through the left or the right side.

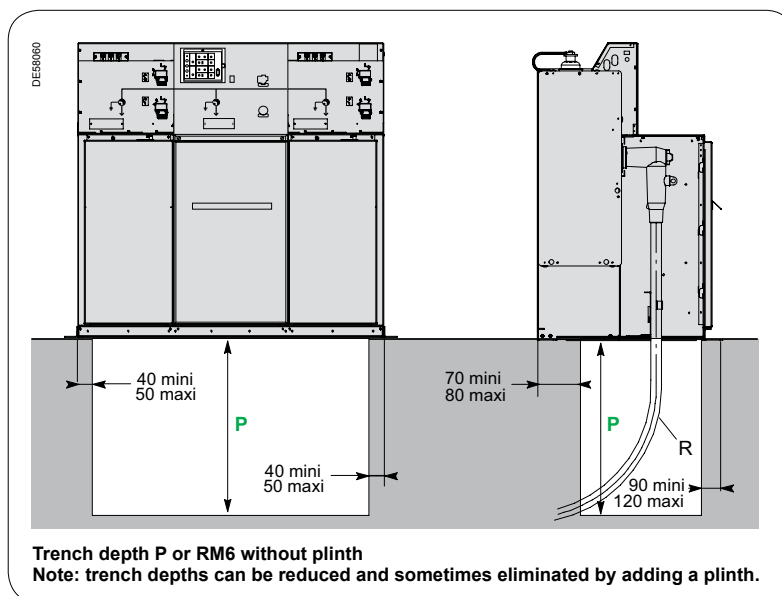

| Cable insulation | Cable | Cross-section (mm ²) | Bending radius | Cable entry through a trench | | Cable entry through a duct | |
|-------------------------------------|--------|----------------------------------|----------------|------------------------------|--------------------|----------------------------|--------------------|
| | | | | P (plug-in) | P (disconnectable) | P (plug-in) | P (disconnectable) |
| Dry insulation | Single | ≤ 150 | 500 | 400 | | 400 | |
| | | 185 to 300 | 600 | 520 | | 520 | |
| | Three | ≤ 150 | 550 | 660 | | 660 | |
| | | 185 | 650 | 770 | | 770 | |
| Paper impregnated non-draining type | Single | ≤ 150 | 500 | | 580 | | 580 |
| | | 185 to 300 | 675 | | 800 | | 800 |
| | Three | ≤ 95 | 635 | | 750 | | 750 |
| | | 150 to 300 | 835 | | 970 | | 970 |

For “transformer” connection via fuse-switch

The cross-sections of “transformer” cables are generally smaller than those of the “network” cables. All the cables are then run through the same space. When straight MV connectors are used, the depth P indicated below can be greater than that of the “network” cables.

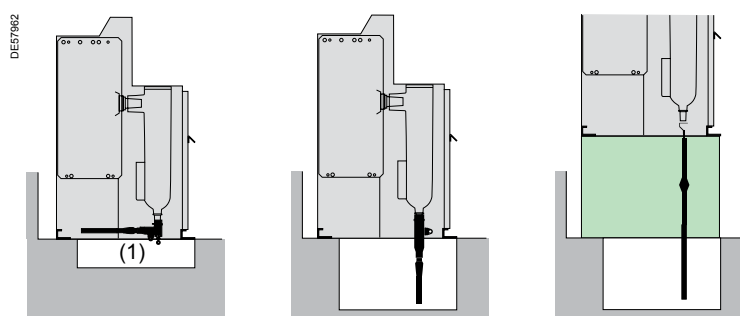

| Cable insulation | Cable | Cross-section (mm ²) | Bending radius | Plug-in Elbow connector | Plug-in Straight connector | Disconnectable (2) |
|------------------|--------|----------------------------------|----------------|-------------------------|----------------------------|--------------------|
| | | | | | | P |
| Dry insulation | Single | 16 to 35 | 335 | 100 | 520 | 335 |
| | | 50 to 70 | 400 | 100 | 520 | 440 |
| | | 95 to 120 | 440 | 100 | 550 | 440 |
| | Three | 35 | 435 | | 520 | 725 |
| | | 50 to 70 | 500 | | 520 | 800 |
| | | 95 | 545 | | 550 | 860 |

(1) Leave a clearance of 100 mm
 (2) 520 mm plinth must be used





order form

order form

Units, options and accessories.

Contents

| | |
|-------------------------|-----|
| Available functions | H-2 |
| Basic unit and options | H-3 |
| Options and accessories | H-5 |

Available functions

| Basic unit characteristics | | | | | | | | | | | | | | | | | | | | |
|------------------------------|-----------|-----|-----|-----|-----|------|------|------|------|------|------|------|-----|-----|-----|-----|-----|-----|-----|---|
| Rated voltage | (kV) | 12 | 12 | 12 | 12 | 17.5 | 17.5 | 17.5 | 17.5 | 24 | 24 | 24 | 24 | 24 | 24 | 24 | 24 | 24 | | |
| Short-time withstand current | (kA rms) | 21 | 21 | 25 | 25 | 21 | 21 | 21 | 21 | 12.5 | 12.5 | 12.5 | 16 | 16 | 16 | 20 | 20 | 20 | | |
| Duration (s) | 1 | 1 | 1 | 1 | 1 | 3 | 1 | 3 | 1 | 1 | 1 | 1 | 1 | 1 | 1 | 3 | 1 | 3 | | |
| Rated current | (A) | 200 | 630 | 200 | 630 | 200 | 200 | 630 | 630 | 200 | 400 | 630 | 200 | 400 | 630 | 200 | 200 | 630 | 630 | |
| Extensions | Functions | | | | | | | | | | | | | | | | | | | |
| NE | I | | | | ■ | | | | | ■ | ■ | | | ■ | ■ | | | ■ | | |
| | D | ■ | | ■ | | ■ | | | | ■ | ■ | | | ■ | ■ | | | ■ | | |
| | B | | | | ■ | | | | ■ | ■ | | | | | ■ | ■ | | ■ | | |
| | QI | | | ■ | | ■ | ■ | | | ■ | | | | ■ | | | ■ | | | |
| | DI | | | ■ | | ■ | ■ | | | ■ | | | | ■ | | | ■ | | | |
| | BI | | | | ■ | | | | ■ | ■ | | | | | | ■ | ■ | | ■ | |
| | II | | | | ■ | | | | ■ | ■ | | ■ | | | ■ | ■ | | | ■ | |
| | IQI | | ■ | | ■ | | | | ■ | ■ | | ■ | | | ■ | ■ | | | ■ | ■ |
| | IIQI | | ■ | | ■ | | | | ■ | ■ | | ■ | | | ■ | ■ | | | ■ | ■ |
| | QIQI | | ■ | | ■ | | | | ■ | ■ | | ■ | | | ■ | ■ | | | ■ | ■ |
| | IDI | | | | ■ | | | | ■ | ■ | | ■ | ■ | | ■ | ■ | | | ■ | ■ |
| | IIDI | | | | ■ | | | | ■ | ■ | | ■ | ■ | | ■ | ■ | | | ■ | ■ |
| | DIDI | | | | ■ | | | | ■ | ■ | | ■ | ■ | | ■ | ■ | | | ■ | ■ |
| | III | | | | ■ | | | | ■ | ■ | | ■ | | | ■ | ■ | | | ■ | ■ |
| | IIII | | | | ■ | | | | ■ | ■ | | ■ | | | ■ | ■ | | | ■ | ■ |
| | IBI | | | | ■ | | | | ■ | ■ | | | | | ■ | ■ | | | ■ | ■ |
| IIBI | | | | ■ | | | | ■ | ■ | | | | | ■ | ■ | | | ■ | ■ | |
| BIBI | | | | ■ | | | | ■ | ■ | | | | | ■ | ■ | | | ■ | ■ | |
| RE | O | | | ■ | ■ | | ■ | | ■ | | | | ■ | | ■ | ■ | ■ | | ■ | |
| | IQI | | ■ | | ■ | | | | ■ | ■ | | ■ | | | ■ | ■ | | | ■ | ■ |
| | IIQI | | ■ | | ■ | | | | ■ | ■ | | ■ | | | ■ | ■ | | | ■ | ■ |
| | QIQI | | ■ | | ■ | | | | ■ | ■ | | ■ | | | ■ | ■ | | | ■ | ■ |
| | IDI | | | | ■ | | | | ■ | ■ | | ■ | ■ | | ■ | ■ | | | ■ | ■ |
| | IIDI | | | | ■ | | | | ■ | ■ | | ■ | ■ | | ■ | ■ | | | ■ | ■ |
| | DIDI | | | | ■ | | | | ■ | ■ | | ■ | ■ | | ■ | ■ | | | ■ | ■ |
| | II | | | | ■ | | | | ■ | ■ | | ■ | | | ■ | ■ | | | ■ | ■ |
| | III | | | | ■ | | | | ■ | ■ | | ■ | | | ■ | ■ | | | ■ | ■ |
| | IIII | | | | ■ | | | | ■ | ■ | | ■ | | | ■ | ■ | | | ■ | ■ |
| | IBI | | | | ■ | | | | ■ | ■ | | | | | ■ | ■ | | | ■ | ■ |
| | IIBI | | | | ■ | | | | ■ | ■ | | | | | ■ | ■ | | | ■ | ■ |
| | BIBI | | | | ■ | | | | ■ | ■ | | | | | ■ | ■ | | | ■ | ■ |
| LE | O | | | ■ | ■ | | ■ | | ■ | | | | ■ | | ■ | ■ | ■ | | ■ | |
| DE | I | | | | ■ | | | | ■ | ■ | | ■ | | | ■ | ■ | | | ■ | ■ |
| | BC | | | | ■ | | | | ■ | ■ | | | | | ■ | ■ | | | ■ | ■ |
| | IC | | | | ■ | | | | ■ | ■ | | | | | ■ | ■ | | | ■ | ■ |
| | O | | | ■ | ■ | | ■ | | ■ | | | | ■ | | ■ | ■ | ■ | | ■ | ■ |
| | Q | ■ | | ■ | | ■ | ■ | | | ■ | | | ■ | | ■ | | ■ | ■ | | ■ |
| | D | | | ■ | | ■ | ■ | | | ■ | | | ■ | | ■ | | ■ | ■ | | ■ |
| | B | | | | ■ | | | | ■ | ■ | | | | | ■ | ■ | | | ■ | ■ |
| | IQI | | ■ | | ■ | | | | ■ | ■ | | | | | ■ | ■ | | | ■ | ■ |
| | IIQI | | ■ | | ■ | | | | ■ | ■ | | | | | ■ | ■ | | | ■ | ■ |
| | IDI | | | | ■ | | | | ■ | ■ | | | ■ | | ■ | ■ | | | ■ | ■ |
| | IIDI | | | | ■ | | | | ■ | ■ | | | ■ | | ■ | ■ | | | ■ | ■ |
| | III | | | | ■ | | | | ■ | ■ | | | | | ■ | ■ | | | ■ | ■ |
| | IIII | | | | ■ | | | | ■ | ■ | | | | | ■ | ■ | | | ■ | ■ |
| | IBI | | | | ■ | | | | ■ | ■ | | | | | ■ | ■ | | | ■ | ■ |
| | IIBI | | | | ■ | | | | ■ | ■ | | | | | ■ | ■ | | | ■ | ■ |
| | Mt | | | | ■ | | | | ■ | ■ | | | | | ■ | ■ | | | ■ | ■ |

N.B.: D and Q functions limited to 200 A
 NE: non-extensible, RE: extensible to the right, LE: extensible to the left, DE: double extensible.

All the performances are available for RM6 Free Combination cubicles.

Basic unit and options



Only one of the boxes (ticked or filled with the needed value) has to be considered between each horizontal line.
 Grey box corresponds to none priced functions.

| Basic unit configuration | | | | | Quantity |
|---|--------------------------|--------------------------|--------------------------|--------------------------|-------------------------------|
| | 5th function | 4th function | 3rd function | 2nd function | 1st function |
| Configuration (one function per box, fill in from the right) 5 functions choice → | <input type="checkbox"/> | <input type="checkbox"/> | <input type="checkbox"/> | <input type="checkbox"/> | <input type="checkbox"/> |
| Option for I, D, B, Ic, Bc functions | | | | | |
| Auxiliary contacts alone For main switch position indication 2 NO - 2 NC and ESw 1 O/C (this option is included in remote operation option) | <input type="checkbox"/> | <input type="checkbox"/> | <input type="checkbox"/> | <input type="checkbox"/> | <input type="checkbox"/> |
| Option for I or Ic function | | | | | |
| Arc killer device | <input type="checkbox"/> | <input type="checkbox"/> | <input type="checkbox"/> | <input type="checkbox"/> | <input type="checkbox"/> |
| Front door of cable connection compartment | <input type="checkbox"/> | <input type="checkbox"/> | <input type="checkbox"/> | <input type="checkbox"/> | <input type="checkbox"/> |
| Bolted | <input type="checkbox"/> | <input type="checkbox"/> | <input type="checkbox"/> | <input type="checkbox"/> | <input type="checkbox"/> |
| Removable with ESw interlocking | <input type="checkbox"/> | <input type="checkbox"/> | <input type="checkbox"/> | <input type="checkbox"/> | <input type="checkbox"/> |
| Removable with ESw interlocking and LBSw interlocking | <input type="checkbox"/> | <input type="checkbox"/> | <input type="checkbox"/> | <input type="checkbox"/> | <input type="checkbox"/> |
| Fault or load current indicator and voltage detection | <input type="checkbox"/> | <input type="checkbox"/> | <input type="checkbox"/> | <input type="checkbox"/> | <input type="checkbox"/> |
| Amp 21D | <input type="checkbox"/> | <input type="checkbox"/> | <input type="checkbox"/> | <input type="checkbox"/> | <input type="checkbox"/> |
| Flair 21D | <input type="checkbox"/> | <input type="checkbox"/> | <input type="checkbox"/> | <input type="checkbox"/> | <input type="checkbox"/> |
| Flair 22D | <input type="checkbox"/> | <input type="checkbox"/> | <input type="checkbox"/> | <input type="checkbox"/> | <input type="checkbox"/> |
| Flair 23DM* | <input type="checkbox"/> | <input type="checkbox"/> | <input type="checkbox"/> | <input type="checkbox"/> | <input type="checkbox"/> |
| VD23 | <input type="checkbox"/> | <input type="checkbox"/> | <input type="checkbox"/> | <input type="checkbox"/> | <input type="checkbox"/> |
| Alpha M | <input type="checkbox"/> | <input type="checkbox"/> | <input type="checkbox"/> | <input type="checkbox"/> | <input type="checkbox"/> |
| Alpha E | <input type="checkbox"/> | <input type="checkbox"/> | <input type="checkbox"/> | <input type="checkbox"/> | <input type="checkbox"/> |
| | | | | | Short-circuit current setting |
| | | | | | 400 A |
| | | | | | 600 A |
| | | | | | 800 A |
| | | | | | 1000 A |
| CT on bushings | <input type="checkbox"/> | <input type="checkbox"/> | <input type="checkbox"/> | <input type="checkbox"/> | <input type="checkbox"/> |
| CT for T200 I on bushings | <input type="checkbox"/> | <input type="checkbox"/> | <input type="checkbox"/> | <input type="checkbox"/> | <input type="checkbox"/> |
| CT for T200 I on bushings + VD23 | <input type="checkbox"/> | <input type="checkbox"/> | <input type="checkbox"/> | <input type="checkbox"/> | <input type="checkbox"/> |
| Remote operation on I function | <input type="checkbox"/> | <input type="checkbox"/> | <input type="checkbox"/> | <input type="checkbox"/> | <input type="checkbox"/> |
| Motor mechanism and auxiliary contacts LBSw | | | | | |
| 2 NO - 2 NC and ESw 1 O/C | | | | | |
| ADD metallic VT in some RM6 cubicle (I function) | | | | | |
| | | | | | 50 Hz |
| | | | | | 60 Hz |
| | | | | | 120 Vac |
| | | | | | 220 Vac |
| | | | | | 24 Vdc |
| | | | | | 48 Vdc |
| | | | | | 60 Vdc |
| | | | | | 110 Vdc |
| | | | | | 125 Vdc |
| | | | | | 220 Vdc |
| Option for D, B, Bc functions | | | | | |
| Front door of cable connection compartment | <input type="checkbox"/> | <input type="checkbox"/> | <input type="checkbox"/> | <input type="checkbox"/> | <input type="checkbox"/> |
| Bolted | <input type="checkbox"/> | <input type="checkbox"/> | <input type="checkbox"/> | <input type="checkbox"/> | <input type="checkbox"/> |
| Removable with ESw interlocking | <input type="checkbox"/> | <input type="checkbox"/> | <input type="checkbox"/> | <input type="checkbox"/> | <input type="checkbox"/> |
| Removable with ESw interlocking and C.B. interlocking | <input type="checkbox"/> | <input type="checkbox"/> | <input type="checkbox"/> | <input type="checkbox"/> | <input type="checkbox"/> |
| Protection relay for lines or transformer protection by circuit breaker (only one type of relay by unit) | <input type="checkbox"/> | <input type="checkbox"/> | <input type="checkbox"/> | <input type="checkbox"/> | <input type="checkbox"/> |
| Relay Sepam series 10 | | | | | |
| | | | | | Standard |
| | | | | | Very sensitive |
| | | | | | Without com. |
| | | | | | With communication |
| | | | | | Auxiliary power supply |
| | | | | | 24 to 115 Vdc |
| | | | | | 100 to 240 Vac |
| | | | | | 120 to 250 Vdc |
| Relay VIP 40 (over current) | <input type="checkbox"/> | <input type="checkbox"/> | <input type="checkbox"/> | <input type="checkbox"/> | <input type="checkbox"/> |
| Relay VIP 45 (over current and earth fault) | <input type="checkbox"/> | <input type="checkbox"/> | <input type="checkbox"/> | <input type="checkbox"/> | <input type="checkbox"/> |
| Relay VIP 410 | <input type="checkbox"/> | <input type="checkbox"/> | <input type="checkbox"/> | <input type="checkbox"/> | <input type="checkbox"/> |
| Relay VIP 400 (over current & earth fault/multi curve in accordance with IEC 255-3) | <input type="checkbox"/> | <input type="checkbox"/> | <input type="checkbox"/> | <input type="checkbox"/> | <input type="checkbox"/> |
| Motor disabled when CB trips | <input type="checkbox"/> | <input type="checkbox"/> | <input type="checkbox"/> | <input type="checkbox"/> | <input type="checkbox"/> |
| Fault tripping auxiliary contact | <input type="checkbox"/> | <input type="checkbox"/> | <input type="checkbox"/> | <input type="checkbox"/> | <input type="checkbox"/> |
| Shunt trip coil for external tripping | <input type="checkbox"/> | <input type="checkbox"/> | <input type="checkbox"/> | <input type="checkbox"/> | <input type="checkbox"/> |
| | | | | | 50 Hz |
| | | | | | 60 Hz |
| | | | | | 120 Vac |
| | | | | | 220 Vac |
| | | | | | 24 Vdc |
| | | | | | 48 Vdc |
| | | | | | 60 Vdc |
| | | | | | 110 Vdc |
| | | | | | 125 Vdc |
| | | | | | 220 Vdc |
| Remote operation on D, B, Bc functions | <input type="checkbox"/> | <input type="checkbox"/> | <input type="checkbox"/> | <input type="checkbox"/> | <input type="checkbox"/> |
| Motor mechanism and auxiliary contacts C.B. 2 NO - 2 NC and ESw 1 O/C (including shunt trip coil) | | | | | |
| | | | | | 50 Hz |
| | | | | | 60 Hz |
| | | | | | 120 Vac |
| | | | | | 220 Vac |
| | | | | | 24 Vdc |
| | | | | | 48 Vdc |
| | | | | | 60 Vdc |
| | | | | | 110 Vdc |
| | | | | | 125 Vdc |
| | | | | | 220 Vdc |
| DE -D et DE-B only. Possibility to add ring type CT in some RM6 cubicle | | | | | |
| Option for Q function | | | | | |
| Auxiliary contacts alone For position indication 2 NO - 2 NC | <input type="checkbox"/> | <input type="checkbox"/> | <input type="checkbox"/> | <input type="checkbox"/> | <input type="checkbox"/> |
| Auxiliary contact for fuses blown | <input type="checkbox"/> | <input type="checkbox"/> | <input type="checkbox"/> | <input type="checkbox"/> | <input type="checkbox"/> |
| Shunt trip coil for external tripping | <input type="checkbox"/> | <input type="checkbox"/> | <input type="checkbox"/> | <input type="checkbox"/> | <input type="checkbox"/> |
| | | | | | 50 Hz |
| | | | | | 60 Hz |
| | | | | | 120 Vac |
| | | | | | 220 Vac |
| | | | | | 24 Vdc |
| | | | | | 48 Vdc |
| | | | | | 60 Vdc |
| | | | | | 110 Vdc |
| | | | | | 125 Vdc |
| | | | | | 220 Vdc |
| Remote operation on Q function | <input type="checkbox"/> | <input type="checkbox"/> | <input type="checkbox"/> | <input type="checkbox"/> | <input type="checkbox"/> |
| Motor mechanism and auxiliary contacts 2 NO - 2 NC (including shunt trip coil) | | | | | |
| | | | | | 50 Hz |
| | | | | | 60 Hz |
| | | | | | 120 Vac |
| | | | | | 220 Vac |
| | | | | | 24 Vdc |
| | | | | | 48 Vdc |
| | | | | | 60 Vdc |
| | | | | | 110 Vdc |
| | | | | | 125 Vdc |
| | | | | | 220 Vdc |
| Option for D, B, Q functions | | | | | |
| Undervoltage coil | <input type="checkbox"/> | <input type="checkbox"/> | <input type="checkbox"/> | <input type="checkbox"/> | <input type="checkbox"/> |
| | | | | | 120 Vac |
| | | | | | 220 Vac |
| | | | | | 24 Vdc |
| | | | | | 48 Vdc |
| | | | | | 110 Vdc |

* Contact us for availabilities

Basic unit and options

Only one of the boxes (ticked or filled with the needed value) has to be considered between each horizontal line.
 Grey box corresponds to none priced functions.

| Basic unit configuration (continued) | | | | | Quantity |
|--|--------------------------|--------------------------|--------------------------|--------------------------|---|
| | 5th function | 4th function | 3rd function | 2nd function | 1st function |
| Configuration (one function per box, fill in from the right) | <input type="checkbox"/> | <input type="checkbox"/> | <input type="checkbox"/> | <input type="checkbox"/> | <input type="checkbox"/> |
| Example → | I | | I | | I |
| Option for operation | | | | | |
| Voltage indicator | | | | | |
| VPIS | <input type="checkbox"/> | <input type="checkbox"/> | <input type="checkbox"/> | <input type="checkbox"/> | <input type="checkbox"/> |
| VPIS Voltage Output (compulsory if with VD23 or Flair 22D*, 23D*, 23DM*, 23DV) | <input type="checkbox"/> | <input type="checkbox"/> | <input type="checkbox"/> | <input type="checkbox"/> | <input type="checkbox"/> |
| VDS | <input type="checkbox"/> | <input type="checkbox"/> | <input type="checkbox"/> | <input type="checkbox"/> | <input type="checkbox"/> |
| | | | | | Network service voltage (kV) |
| | | | | | 10 <input type="checkbox"/> 15 <input type="checkbox"/> |
| | | | | | 6 <input type="checkbox"/> 11 <input type="checkbox"/> 20 <input type="checkbox"/> |
| | | | | | 6.6 <input type="checkbox"/> 13.8 <input type="checkbox"/> 22 <input type="checkbox"/> |
| Key locking devices | | | | | |
| | | | | | Flat key type <input type="checkbox"/> |
| | | | | | Tubular key type <input type="checkbox"/> |
| | | | | |   |
| Type R1 (on I and B functions) | <input type="checkbox"/> | <input type="checkbox"/> | <input type="checkbox"/> | <input type="checkbox"/> | <input type="checkbox"/> |
| | | | | | On switch or circuit breaker <input type="checkbox"/> |
| | | | | | On earth switch <input type="checkbox"/> |
| Type R2 (on I and B functions) | <input type="checkbox"/> | <input type="checkbox"/> | <input type="checkbox"/> | <input type="checkbox"/> | <input type="checkbox"/> |
| Type R6 (on Q or D functions) | <input type="checkbox"/> | <input type="checkbox"/> | <input type="checkbox"/> | <input type="checkbox"/> | <input type="checkbox"/> |
| Type R7 (on Q or D functions) | <input type="checkbox"/> | <input type="checkbox"/> | <input type="checkbox"/> | <input type="checkbox"/> | <input type="checkbox"/> |
| Type R8 (on Q or D functions) | <input type="checkbox"/> | <input type="checkbox"/> | <input type="checkbox"/> | <input type="checkbox"/> | <input type="checkbox"/> |

* contact us for availability

Options and accessories

Only one of the boxes (ticked or filled with the needed value) has to be considered between each horizontal line.
 Grey box corresponds to none priced functions.

Specific option for one function

| | | | |
|--|--------------------------------------|--------------------------------|--|
| Bushing for I function | | | |
| Plug in 400 A type B | | | <input type="checkbox"/> |
| Bolted M16 screw type C (compulsory with 17.5 or 24 kV-630 A) | | | <input type="checkbox"/> |
| Bolted 5/8" ANSI | | | <input type="checkbox"/> |
| Bushing for D function | | | |
| Plug in 200 A type A (limited to 12.5 kA 1 s) | | | <input type="checkbox"/> |
| Plug in 400 A type B (limited to 16 kA 1 s) | | | <input type="checkbox"/> |
| Bolted M16 screw type C (compulsory with 17.5 or 24 kV-630 A) | | | <input type="checkbox"/> |
| Bushing well ANSI (limited to 12.5 kA 1 s) | | | <input type="checkbox"/> |
| Bushing for B function | | | |
| Bolted M16 type C | | | <input type="checkbox"/> |
| Bolted 5/8" ANSI | | | <input type="checkbox"/> |
| Bushing for Q function | | | |
| Plug in 200 A | | | <input type="checkbox"/> |
| Heat shrinkable terminal for fuse chamber | | | <input type="checkbox"/> |
| Cable type for I, Ic functions | Single core <input type="checkbox"/> | | Three-core <input type="checkbox"/> |
| Bottom plate in cable box (compulsory in case of three-core cable) | | | <input type="checkbox"/> |
| Cable type for D, B, Bc functions | Single core <input type="checkbox"/> | | Three-core <input type="checkbox"/> |
| Bottom plate in cable box (compulsory in case of three-core cable) | | | <input type="checkbox"/> |
| Cable type for O function | Single core <input type="checkbox"/> | | Three-core <input type="checkbox"/> |
| Bottom plate in cable box (compulsory in case of three-core cable) | | | <input type="checkbox"/> |
| In and fuse type for Q function | 6 kV <input type="checkbox"/> | 10 kV <input type="checkbox"/> | 12/24 kV & 10/100 A <input type="checkbox"/> |
| (fuses to be procured separately) | 16 to 100 A <input type="checkbox"/> | 125 A <input type="checkbox"/> | |

Global option

| | | | | |
|---|--|---|-------------------------------------|-------------------------------------|
| Pressure detection | | | | Without <input type="checkbox"/> |
| Manometer | Arabic <input type="checkbox"/> | Scandinavian <input type="checkbox"/> | Standard <input type="checkbox"/> | |
| or pressure switch | | Scandinavian <input type="checkbox"/> | Standard <input type="checkbox"/> | |
| Door with window (for I, D and B functions) <input type="checkbox"/> | | | | |
| Deep cable box for I and D or B functions | | | | |
| (enables surge arrestors to be fitted) <input type="checkbox"/> | | | | |
| Additional earth busbar | | | | |
| (compulsory if earth fault > 6 kA 1 s) <input type="checkbox"/> | | | | |
| Internal arc cable box 20 kA 1 s for I, D, B, O, Ic, Bc functions | | | | |
| (unable to coexist with door with window) <input type="checkbox"/> | | | | |
| Autotransfer system for I function I (48 Vdc electrical motorization compulsory) | | | | |
| Fixation support T200 I to RM6 | | Without <input type="checkbox"/> | With <input type="checkbox"/> | |
| Changeover type | ATS 1/2 network <input type="checkbox"/> | ATS 1/2 genset <input type="checkbox"/> | BTA 2/3 <input type="checkbox"/> | |
| Communication modem | GSM/GPRS <input type="checkbox"/> | FSK (radio) <input type="checkbox"/> | RS485 <input type="checkbox"/> | |
| Protocol | | IEC101/104 <input type="checkbox"/> | DNP3/IP <input type="checkbox"/> | |
| Current measurement (only cables, if CT on RM6 bushings) | | | | |
| sensors + cables | Single core <input type="checkbox"/> | Single core <input type="checkbox"/> | Three-core <input type="checkbox"/> | Three-core <input type="checkbox"/> |
| | AC 5 m <input type="checkbox"/> | AC 10 m <input type="checkbox"/> | AH 5 m <input type="checkbox"/> | AH 10 m <input type="checkbox"/> |
| Connection cable to motorization 1 | | 3 m <input type="checkbox"/> | 5 m <input type="checkbox"/> | 10 m <input type="checkbox"/> |
| Connection cable to bus tie (only for BTA 2/3) | | | 5 m <input type="checkbox"/> | 10 m <input type="checkbox"/> |
| Connection cable to motorization 2 | | 3 m <input type="checkbox"/> | 5 m <input type="checkbox"/> | |

Accessories

| | | | |
|---|--------------------------------|--|--------------------------------------|
| Raising plinth | | h = 260 mm <input type="checkbox"/> | h = 520 mm <input type="checkbox"/> |
| Set of 3 MV fuses Fusarc CF | | | Rating (A) <input type="checkbox"/> |
| Phase comparator | | | |
| Test box for circuit breaker relay (VAP 6) | | | |
| PS100 backup power supply | | | |
| Exhaust gas | | To the bottom <input type="checkbox"/> | To the rear <input type="checkbox"/> |
| Additional operating handle | | Standard <input type="checkbox"/> | Longer <input type="checkbox"/> |
| | | | Super long <input type="checkbox"/> |
| Additional extension kit | 1 fct <input type="checkbox"/> | 2 fct <input type="checkbox"/> | 3 fct <input type="checkbox"/> |
| | | | 4 fct <input type="checkbox"/> |
| | | | 5 fct <input type="checkbox"/> |
| Additional instructions | | | DE Mt <input type="checkbox"/> |
| Installation and civil engineering instructions | | French <input type="checkbox"/> | English <input type="checkbox"/> |

Schneider 施耐德電機授權經銷商
Electric

東技企業股份有限公司
普得企業股份有限公司

總公司：台北市內湖區行愛路68號6樓

電話：(02)8791-8588

傳真：(02)8791-9588

E-mail: toyotech@ms37.hinet.net

中辦處：(04)2296-9388

高辦處：(07)227-2133

網址：www.toyotech.com.tw

Schneider Electric Industries SAS

35, rue Joseph Monier
CS30323

F - 92505 Rueil-Malmaison cedex (France)

RCS Nanterre 954 503 439
Share capital: €896,313,776
www.schneider-electric.com

AMTED398032EN

As the standards, specifications and designs change from time to time, please ask for confirmation of the information given in this publication.



*This document has been printed
on ecological paper*

Design: SYNTHÈSE ECA, Schneider Electric Industries SAS
Photos: Schneider Electric Industries SAS
Printing: Altavia Connexion - Made in France

01-2014