



VAMP 125

Unit for flexible arc flash protection

Modern society heavily depends on an uninterrupted supply of electric power. Prolonged power outages may cause loss of business to the power supplier and loss of production to the power consumer.

An arc flash protection unit is a protective device used to enhance the environment of the installation in different situations.

Schneider Electric's Vamp range is the pioneer in the field of arc flash protection with close to 15,000 arc flash systems and 300,000 sensors in service worldwide.

m.vamp.fi

Life Is On

Schneider
Electric

VAMP 125

We can supply an arc flash protection system tailored to your application



An arc flash protection unit is a protective device used to enhance the environment of your installation.

VAMP 125 at a glance

- **Dedicated unit for each bay**

VAMP 125 Arc flash protection units are versatile and independently operating devices for bay based protection.

- **Designed for partners**

They offer optimized and cost effective solution for panel builders and OEMs.

- **Hardware**

- Interface for 4 Arc flash sensors
- 2 output relays: 1 relay output,
1 high speed output
- 1 change-over output for self-supervision
- Wide range auxiliary power supply
- External inputs for remote control
- External input for current criteria

User benefits

- **Suitable product**

Fit to various customer segments like utilities, commercial and industrial buildings, mining, steel, cement and other industry, OEMs.

- **Easy to integrate**

- QR code for registration
- One type designation only:
various documented protection schemes

- **Easy to use**

- Easy entry to arc flash protection
- One variant with wide-range power supply
- Optimized for standard switchgear configurations
- Standard solution for panel builder



Why arc flash protection?

Traditional time-grading or blocking based system may not be suitable to address fast answer in the event of a detected error in the installation. Further, high-impedance type earth-faults may cause prolonged operation times of earth-fault relays leading to the significant release of arcing energy.

These facts pose a considerable risk to operation personnel and economical assets.

Highest risk for the arc flash phenomena occurs during commissioning and maintenance of the power system and after possible recommissioning of the power distribution boards.

Arc flash protection, utilizing detection of the arc flash, is designed to operate faster than traditional protection relays hence their performance enhance electrical installation's availability.

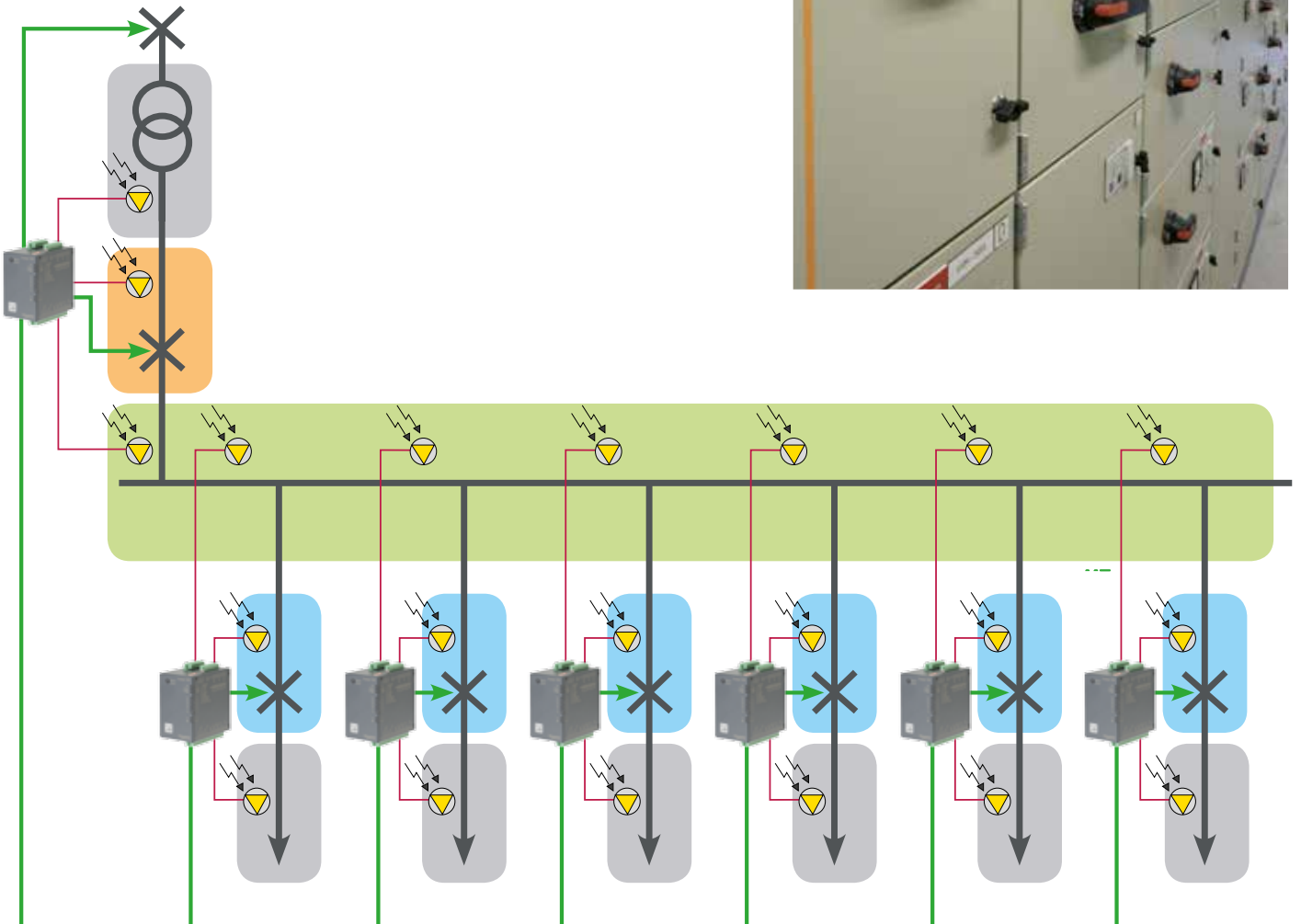

VAMP 125 user interface



VAMP 125 - arc flash protection made compact, easy and effective

Operating status indications

- Power
- Blocking
- Service required

Sensor and trip output status

- Sensors S1, S2, S3 and S4
- T1 and T2

Binary input status

- External current
- External master trip

Terminal X1 and label texts

- Binary trip out
- Binary output ground
- Binary master trip output / input
- Block input
- Reset input
- Current status input
- Service status output

Terminal X5 label texts

- T1 and T2
- Auxiliary power

Terminal X2 label texts

- Sensors S1, S2, S3 and S4

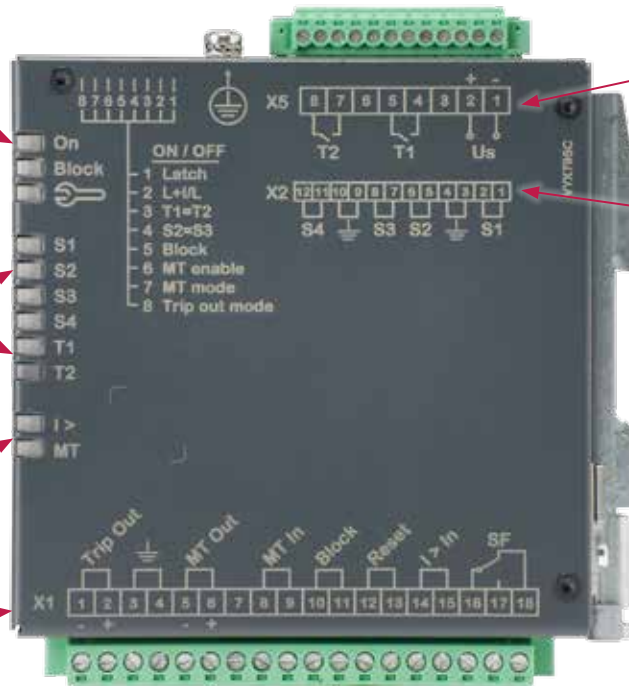

Reset / Install push button



QR code

- Documentation tracking and product registration

Panel mounting

Optional door mounting bracket supports installation to a door for easy access of system status data.



Mounting bracket

- Order code REL52901
- Depth dimension behind door 126 mm
- Depth dimension can be reduced another 10 mm down to 115 mm in case the DIN rail mounting bracket is removed from the device.

Applications

One or two incomers and several outgoing feeders

The following applications are typically used for arc flash protection in MV power distribution in commercial buildings and light industries. The arc flash protection is commercialized using VAMP 125 arc flash protection units, VA1-DAX type point sensors and appropriate wiring between the units.

Operation

Incomer

Incomer cubicle has three sensors. Activation of sensor S1 operates T1 output. Should the arc fault happen in the CB compartment sensor S3 activates and controls upstream CB via T2 output. Equally, if the arc fault happens in the power transformer bushings, an upstream CB is tripped through T2.

Outgoing feeder

All outgoing feeders have similar operation. Should the sensor S1 activate in the busbar compartment, the pick-up signal is transferred via MT out to VAMP 125 located in the incomer feeder and trips incoming feeder CB through T2 output. Equally, should the sensor S2 activate a pick-up, signal is transferred to incomer feeder CB. Possible arc fault in the cable termination is tripped by T2.

Single incomer feeder application

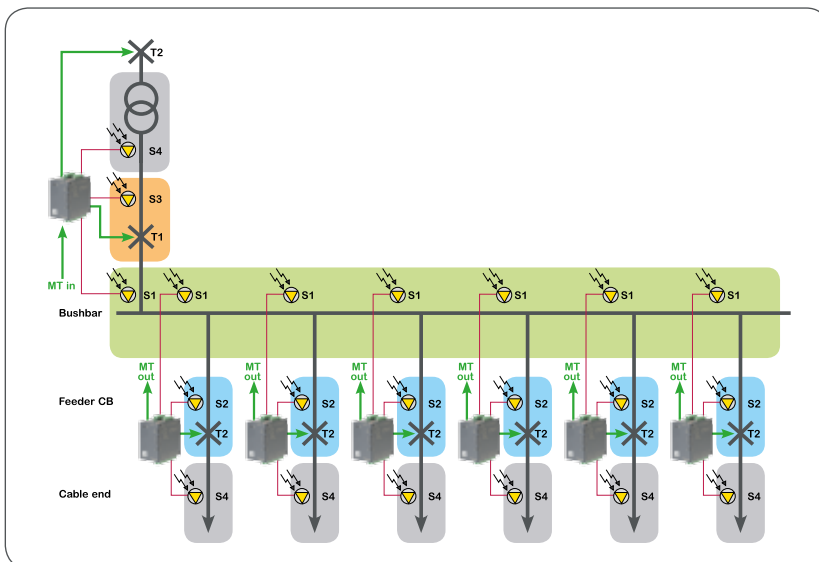

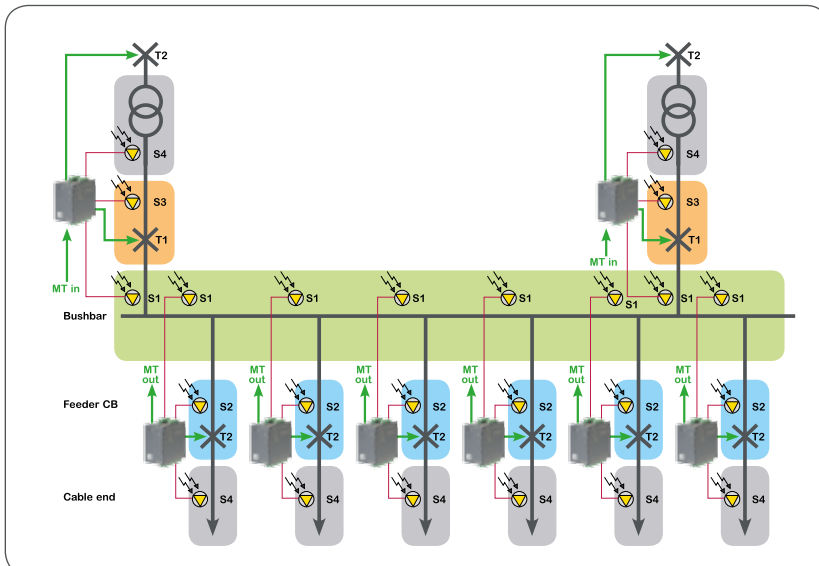

Operation of two incomer feeder application



Operation of the arc flash protection scheme is identical to the single incomer feeder application, except the activation of the arc flash fault in the bus bar or in outgoing feeder breakers are connected to both incomers.

Sensors and accessories

Sensors

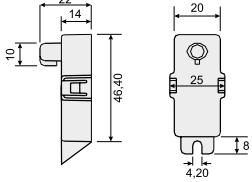
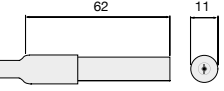
Point sensor VA1DA	Point sensor VA1EH	Shielded arc sensor VA2DV
<ul style="list-style-type: none"> Typically used for MV and LV air insulated switchgears IP 20 Surface mounting Continuous self-supervision 	<ul style="list-style-type: none"> Typically used for MV air insulated switchgears and wind power installations IP 65 Tube mounting Continuous self-supervision 	<ul style="list-style-type: none"> Typically used for wind power installations in harsh environment IP 65 Placed in a hole and fixed with a nut Continuous self-supervision
		
		

VAMP %&)





Chung Mei (Taiwan)



TOYO (Taiwan)

- Option: photoelectric smoke detector for fire alarm early protection
**refer to operation manual for installation instruction*
- Option: 16 points digital I/O module with modbus RS-485 communication interface

Accessories

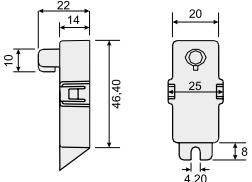
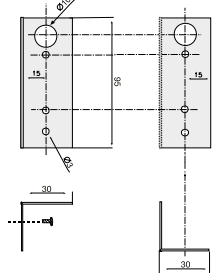
Sensor mounting plate Z-shaped, VYX001	Sensor mounting plate L-shaped, VYX002	Door mount bracket REL52901
<ul style="list-style-type: none"> Wall mounting to VA1DA-x sensors (no extra holes in the switchgear) 	<ul style="list-style-type: none"> Wall mounting to VA1DA-x sensors (no extra holes in the switchgear) 	<ul style="list-style-type: none"> Optional door mounting bracket supports installation to a door for easy access of system status data.
		
		

Dimensions and mounting

Main dimensions

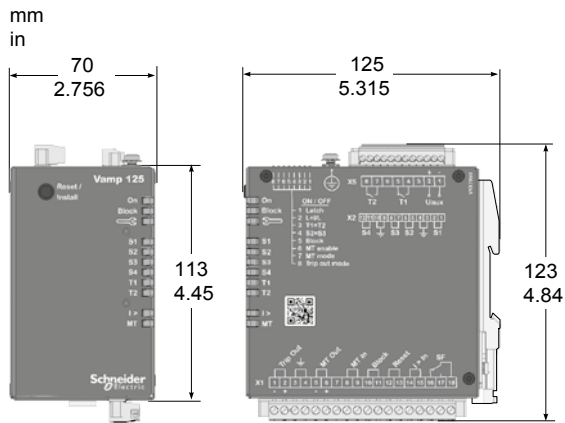

DIN rail mounting

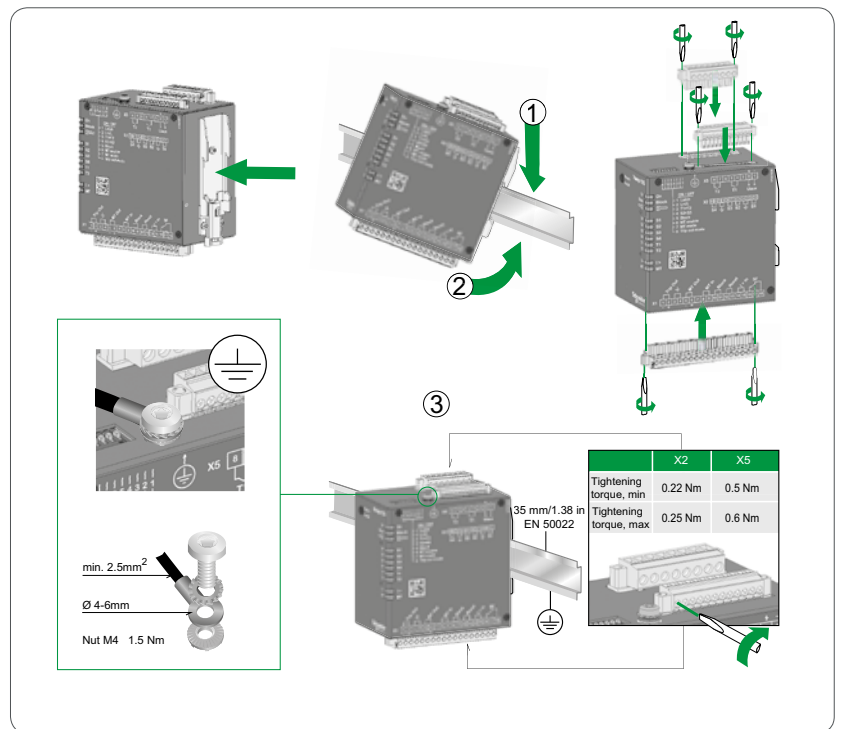

Panel mounting

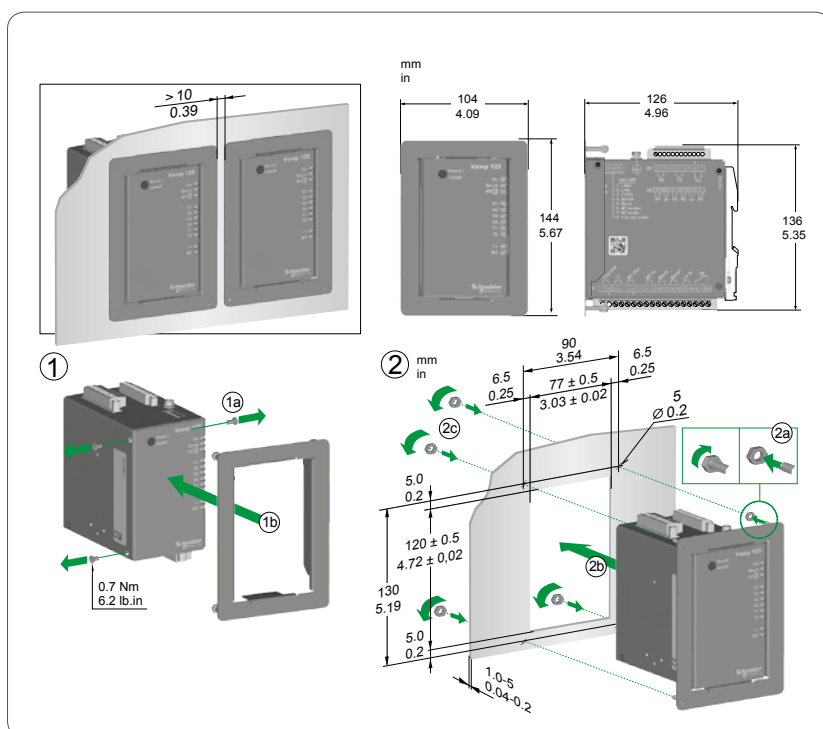

Order codes

Order reference	Cortec type	Explanation
REL52900	V125	Arc flash protection unit



Accessories

Order reference	Cortec type	Explanation	Note
REL52804	VA 1 DA-6	Arc Sensor	Cable length 6m
REL52801	VA 1 DA-20	Arc Sensor	Cable length 20m
REL52809	VA 1 EH-6	Arc Sensor (Pipe type)	Cable length 6m
REL52807	VA 1 EH-20	Arc Sensor (Pipe type)	Cable length 20m
	VA 1 EH-6-IP	Arc Sensor (Pipe type, IP65)	Cable length 6m
	VA 1 EH-20-IP	Arc Sensor (Pipe type, IP65)	Cable length 20m
	VA 2 DV-15	Arc Sensor, shielded (metal pipe)	Cable length 15m
	VA 2 DV-20	Arc Sensor, shielded (metal pipe)	Cable length 20m
REL52901		Door mount bracket	For V125
REL52828	VYX001	Surface Mounting Plate for Sensors	Z-shaped
REL52829	VYX002	Surface Mounting Plate for Sensors	L-shaped
	VYX 628	Surface Mounting Plate for VA 1 DV Sensor	U-shaped

Technical data, tests and enviromental

VAMP 125 arc flash protection unit, technical data

Auxiliary power supply	
Uaux	24 – 240 (-20% +10%) V ac/dc
Power consumption	8 W

Hybrid output, T1	
Number of contacts	1, NO
Rated voltage	250 V ac/dc
Continuous carry	5 A
Minimum making current	-
Typical operation time	≤1 ms
Make and carry, 0.5 s	30 A
Make and carry, 3 s	15 A
Breaking capacity, AC	2 000 VA
Breaking capacity, DC (L/R=40 ms)	
at 48 V dc:	1.15 A
at 110 V dc:	0.5 A
at 220 V dc:	0.25 A
Contact material	AgNi 90/10
Terminal block - MSTB2.5 - 5.08	Wire dimension Maximum 2.5 mm ² (13 – 14 AWG) Minimum 1.5 mm ² (15 – 16 AWG)

Trip contact, T2	
Number of contacts	1, NO
Rated voltage	250 V ac/dc
Continuous carry	5 A
Minimum making current	100 mA @ 24 Vdc
Typical operation time	≤8 ms
Make and carry, 0.5 s	30 A
Make and carry, 3 s	15 A
Breaking capacity, AC	2 000 VA
Breaking capacity, DC (L/R=40 ms)	
at 48 V dc:	1.15 A
at 110 V dc:	0.5 A
at 220 V dc:	0.25 A
Contact material	AgNi 90/10
Terminal block - MSTB2.5 - 5.08	Wire dimension Maximum 2.5 mm ² (13 – 14 AWG) Minimum 1.5 mm ² (15 – 16 AWG)

Self-supervision contact; SF	
Number of contacts	2, NC/NO
Rated voltage	250 V ac/dc
Continuous carry	5 A
Minimum making current	100 mA @ 24 Vdc
Make and carry, 0.5 s	30 A
Make and carry, 3 s	15 A
Breaking capacity, AC	2 000 VA
Breaking capacity, DC (L/R=40 ms)	
at 48 V dc:	1.15 A
at 110 V dc:	0.5 A
at 220 V dc:	0.25 A
Contact material	AgNi 90/10
Terminal block - MSTB2.5 - 5.08	Wire dimension Maximum 2.5 mm ² (13 – 14 AWG) Minimum 1.5 mm ² (15 – 16 AWG)

Binary outputs; Trip Out, MT Out	
Number if outputs	2
Rated output voltage	+24 V dc SELV (max +32 V dc unloaded)
Rated output current	20 mA
Terminal block: - MSTB2.5 - 5.08	Wire dimension: Maximum 2.5 mm ² (13 – 14 AWG) Minimum 1.5 mm ² (15 – 16 AWG)

Binary inputs; MT In, Block, Reset, I> IN	
Number of inputs	4
Voltage withstand	250 V ac/dc
Nominal operation voltage	24 – 240 V ac/dc (max. 250 V ac/dc)
Typical switching threshold	12 V dc ±5 %
Current drain	approx. 3 mA
Terminal block: - MSTB2.5 - 5.08	Wire dimension: Maximum 2.5 mm ² (13 – 14 AWG) Minimum 1.5 mm ² (15 – 16 AWG)

Arc sensor inputs; S1 – S4	
Number if inputs	4
Supply to sensors	8 V dc
Grounding	4 pcs. ground termination on connector
Terminal block: MC 1.5 - 3.5	Wire dimension: Maximum 1.5 mm ² (15 - 16 AWG) Minimum 0.14 mm ² (25 - 26 AWG)

Disturbance tests

Test	Standard & Test class / level	Test value
Emission	IEC/EN 60255-26 (ed3)	
- Conducted	EN 55022, Class A & CISPR 22	0.15 – 80 MHz
- Emitted	EN 55011, Class A / IEC 60255-25 / CISPR 11 EN 55011, Class A & CISPR 11	30 – 1000 MHz
BI line (IN)	3 pcs	
BO lines (OUT)	3 pcs	
Immunity	IEC/EN 60255-26 (ed3) Zone A	
- 1Mhz damped oscillatory wave	IEC/EN 61000-4-18	±2.5kVp CM, ±2.5kVp DM
- Static discharge (ESD)	IEC/EN 61000-4-2 Level 4	±8 kV contact, ±15 kV air
- Emitted HF field	IEC/EN 61000-4-3 Level 3	80 – 2700 MHz, 10 V/m
- Fast transients (EFT)	IEC/EN 61000-4-4 Level 4	±4 kV, 5/50 ns, 5 kHz
- Surge	IEC/EN 61000-4-5 Level 3	±4 kV, 1.2/50 µs, CM ±2 kV, 1.2/50 µs, DM
- Conducted HF field	IEC/EN 61000-4-6 Level 3	0.15 – 80 MHz, 10 Vemf
- Power-frequency magnetic field	IEC/EN 61000-4-8	300 A/m (continuous), 1000 A/m 1 – 3 s
- Pulse magnetic field	IEC/EN 61000-4-9 Level 5	1000A /m, 1.2/50 µs
- AC and DC voltage dips	IEC/EN 61000-4-29, IEC/EN 61000-4-11t	0% of rated voltage • AC: 5 cycles • DC: 100 ms 40% of rated voltage • AC: 10 cycles • DC: 200 ms 70% of rated voltage • AC: 25 cycles • DC: 500 ms
- AC and DC voltage interruptions	IEC/EN 61000-4-29, IEC/EN 61000-4-11	100% interruption • AC: 250 cycles • DC: 5 s
- Voltage alternative component	IEC/EN 61000-4-17	15% of operating voltage (DC) / 10 min

Electrical safety tests

Test	Standard & Test class / level	Test value
- Impulse voltage withstand	IEC/EN 60255-27	5 kV, 1.2/50 ms, 0.5 J
- Dielectric test	IEC/EN 60255-27	2 kV, 50 Hz
- Insulation resistance	IEC/EN 60255-27	
- Protective bonding resistance	IEC/EN 60255-27	
- Power supply burden	IEC 60255-1	

Mechanical tests

Test	Standard & Test class / level	Test value
Device in operation		
- Vibrations	IEC 60255-21-1, Class II / IEC 60068-2-6, Fc	1 Gn, 10 Hz – 150 Hz
- Shocks	IEC 60255-21-2, Class II / IEC 60068-2-27, Ea	10 Gn / 11ms
- Seismic	IEC 60255-21-3 Method A, Class II	2 G horizontal / 1 G vertical, 1Hz- 35 Hz
Device de-energized		
- Vibrations	IEC 60255-21-1, Class II / IEC 60068-2-6, Fc	2 Gn, 10 Hz – 150 Hz
- Shocks	IEC 60255-21-2, Class II / IEC 60068-2-27, Ea	30 Gn / 11 ms
- Bump	IEC 60255-21-2, Class II / IEC 60068-2-27, Ea	20 Gn / 16 ms

Environmental tests

Test	Standard & Test class / level	Test value
Device in operation		
- Dry heat	EN / IEC 60068-2-2, Bd	70°C (158°F)
- Cold	EN / IEC 60068-2-1, Ad	-40°C (-40°F)
- Damp heat, cyclic	EN / IEC 60068-2-30, Db	<ul style="list-style-type: none"> • From 25°C (77°F) to 55°C (131°F) • From 93% RH to 98% RH • Testing duration: 6 days
- Damp heat, static	EN / IEC 60068-2-78, Cab	<ul style="list-style-type: none"> • 40°C (104°F) • 93% RH • Testing duration: 10 days
Change of temperature	IEC / EN 60068-2-14, Nb	<ul style="list-style-type: none"> • Lower Temp -40°C • Upper Temp 70°C • 5 Cycles
Device in storage		
- Dry heat	EN / IEC 60068-2-2, Bb	80°C (176°F)
- Cold	EN / IEC 60068-2-1, Ab	-40°C (-40°F)

Environmental conditions

Ambient temperature, in-service	-40 – 65°C (-40 – 149°F)
Ambient temperature, storage	-40 – 80°C (-40 – 176°F)
Relative air humidity	< 95%
Maximum operating altitude	2000 m (6561.68 ft)

Casing

Degree of protection (IEC 60529)	IP20
Dimensions (w x h x d):	70 x 135 x 123 mm / 2.76 x 5.31 x 4.84 in
Weight	0.9 kg (1.987 lb)
Maximum operating altitude	2000 m (6561.68 ft)



Device track record

- Schneider Electric's VAMP range specialises in protection relays, arc flash protection and measuring and monitoring units for power systems.
- VAMP's medium-voltage and sub-transmission protection relays are used in numerous applications, from overhead line feeders and substations to power plants and industrial power system. Their integrated arc flash fault protection functionality enhances both people and property environment of care and has made VAMP a leading range in arc flash protection worldwide. VAMP products meet the updated international standards and regulations.

Schneider Electric 施耐德電機授權經銷商

東技企業股份有限公司

普得企業股份有限公司

總公司：台北市內湖區行愛路68號6樓

電話：(02)8791-8588

傳真：(02)8791-9588

E-mail: toyotech@ms37.hinet.net

中辦處：(04)2296-9388

高辦處：(07)227-2133

網址：www.toyotech.com.tw

Schneider Electric Industries SAS
35, rue Joseph Monier
CS 30323
F - 92506 Rueil Malmaison Cedex (France)
Tel.: +33 (0) 1 41 29 70 00
www.schneider-electric.com/vamp-protection

Life Is On

Schneider
Electric